



OWNER'S MANUAL

**⚠ Read this manual carefully
before operating this vehicle.**

MT-09SP

MOTORCYCLE

MTN890D (MT-09 SP)

BAM-2U199-E1

Location of important labels	1
Safety information	2
Description	3
Special features	4
Instrument and control functions	5
For your safety – pre-operation checks	6
Operation and important riding points	7
Periodic maintenance and adjustment	8
Motorcycle care and storage	9
Specifications	10
Consumer information	11
Index	12



เครื่องวิทยุคมนาคมนี้ ได้รับยกเว้น ไม่ต้องได้รับ
ใบอนุญาตให้มี ใช้ซึ่งเครื่องวิทยุคมนาคม
หรือตั้งสถานีวิทยุคมนาคมตามประกาศ กสทช.
เรื่อง เครื่องวิทยุคมนาคม และสถานีวิทยุ
คมนาคมที่ได้รับยกเว้นไม่ต้องได้รับใบอนุญาต
วิทยุคมนาคม ตามพระราชบัญญัติวิทยุ
คมนาคม พ.ศ. 2498



nab. | โทรคมนาคม
กำกับดูแลเพื่อประชาชน
Call Center 1200 (Inswr)

เครื่องโทรคมนาคมและอุปกรณ์นี้ มีความสอดคล้องตาม
มาตรฐานหรือข้อกำหนดทางเทคนิคของ กสทช.

 **Read this manual carefully before operating this vehicle. This manual should stay with this vehicle if it is sold.**

Welcome to the Yamaha world of motorcycling!

As the owner of the MTN890D, you are benefiting from Yamaha's vast experience and newest technology regarding the design and manufacture of high-quality products, which have earned Yamaha a reputation for dependability.

Please take the time to read this manual thoroughly, so as to enjoy all advantages of your MTN890D. The Owner's Manual does not only instruct you in how to operate, inspect and maintain your motorcycle, but also in how to safeguard yourself and others from trouble and injury.

In addition, the many tips given in this manual will help keep your motorcycle in the best possible condition. If you have any further questions, do not hesitate to contact your Yamaha dealer.

The Yamaha team wishes you many safe and pleasant rides. So, remember to put safety first!

Yamaha continually seeks advancements in product design and quality. Therefore, while this manual contains the most current product information available at the time of printing, there may be minor discrepancies between your motorcycle and this manual. If there is any question concerning this manual, please consult a Yamaha dealer.





Please read this manual carefully and completely before operating this motorcycle.

Important manual information

EAU10134

Particularly important information is distinguished in this manual by the following notations:

	This is the safety alert symbol. It is used to alert you to potential personal injury hazards. Obey all safety messages that follow this symbol to avoid possible injury or death.
 WARNING	A WARNING indicates a hazardous situation which, if not avoided, could result in death or serious injury.
NOTICE	A NOTICE indicates special precautions that must be taken to avoid damage to the vehicle or other property.
TIP	A TIP provides key information to make procedures easier or clearer.

*Product and specifications are subject to change without notice.

EAU10202

**MTN890D
OWNER'S MANUAL
©2022 by Yamaha Motor Co., Ltd.
1st edition, December 2021
All rights reserved.
Any reprinting or unauthorized use
without the written permission of
Yamaha Motor Co., Ltd.
is expressly prohibited.
Printed in Japan.**

Table of contents

Location of important labels	1-1	Fuel	5-21	General maintenance and lubrication chart	8-5
Safety information	2-1	Fuel tank overflow hose	5-23	Checking the spark plugs.....	8-9
Helmets	2-5	Catalytic converter	5-23	Canister	8-10
Description	3-1	Seat	5-24	Engine oil	8-10
Left view	3-1	Rider footrest position	5-24	Why Yamalube.....	8-12
Right view	3-2	Handlebar position	5-25	Coolant	8-13
Controls and instruments	3-3	Adjusting the front fork	5-25	Air filter element.....	8-14
Special features	4-1	Adjusting the shock absorber assembly.....	5-28	Checking the engine idling speed	8-14
Cruise control system.....	4-1	Luggage strap holders	5-30	Valve clearance.....	8-15
“D-MODE”	4-3	Auxiliary DC connectors	5-30	Tires	8-15
“TCS-MODE”.....	4-4	Sidestand	5-30	Cast wheels	8-17
Quick shifter	4-6	Ignition circuit cut-off system	5-31	Adjusting the clutch lever free play.....	8-18
BC.....	4-6	For your safety – pre-operation checks	6-1	Checking the brake lever free play.....	8-18
Instrument and control functions ...	5-1	Operation and important riding points	7-1	Brake light switches	8-19
Immobilizer system.....	5-1	Engine break-in	7-1	Checking the front and rear brake pads	8-19
Main switch/steering lock.....	5-2	Starting the engine.....	7-2	Checking the brake fluid level	8-20
Handlebar switches	5-3	Shifting	7-3	Changing the brake fluid	8-21
Indicator lights and warning lights.....	5-5	Tips for reducing fuel consumption.....	7-5	Drive chain slack.....	8-22
Display	5-8	Parking	7-5	Cleaning and lubricating the drive chain.....	8-24
Settings MENU	5-13	Periodic maintenance and adjustment	8-1	Checking and lubricating the cables.....	8-24
Clutch lever	5-18	Tool kit	8-2	Checking and lubricating the throttle grip.....	8-25
Shift pedal	5-18	Periodic maintenance chart for the emission control system.....	8-3	Checking and lubricating the brake and shift pedals.....	8-25
Brake lever.....	5-19				
Brake pedal	5-19				
Brake control system (BC).....	5-19				
Fuel tank cap	5-21				

Table of contents

Checking and lubricating the brake and clutch levers.....	8-26
Checking and lubricating the sidestand	8-26
Lubricating the swingarm pivots ...	8-27
Checking the front fork.....	8-27
Checking the steering	8-28
Checking the wheel bearings	8-28
Battery	8-28
Replacing the fuses.....	8-30
Vehicle lights	8-32
License plate light	8-32
Supporting the motorcycle.....	8-32
Troubleshooting	8-33
Troubleshooting chart	8-34
Motorcycle care and storage	9-1
Matte color caution	9-1
Care.....	9-1
Storage.....	9-3
Specifications.....	10-1
Consumer information	11-1
Identification numbers.....	11-1
Diagnostic connector	11-2
Vehicle data recording	11-2
Index	12-1

Location of important labels

EAU10386

1

Read and understand all of the labels on your vehicle. They contain important information for safe and proper operation of your vehicle. Never remove any labels from your vehicle. If a label becomes difficult to read or comes off, a replacement label is available from your Yamaha dealer.

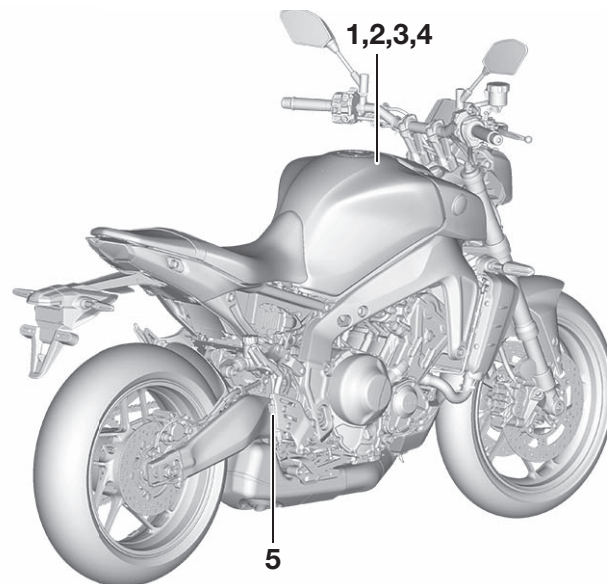
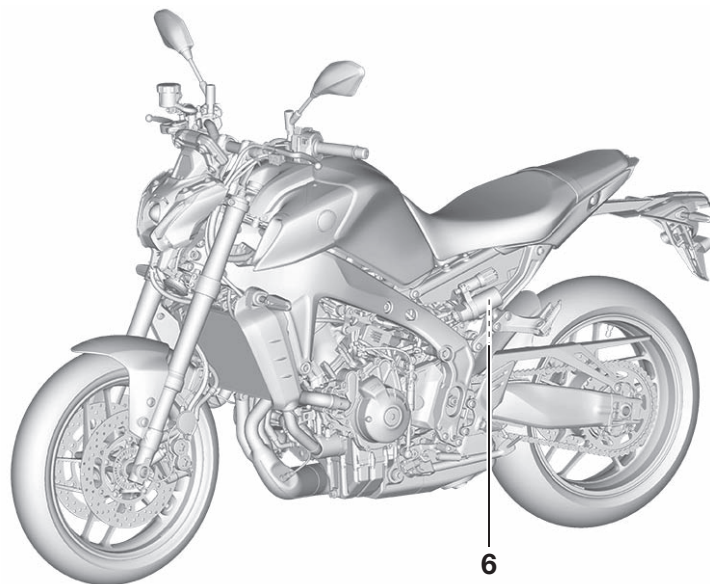

Location of important labels

1



2



1

3



4



5

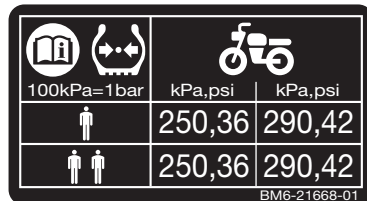

6



2 Be a Responsible Owner

As the vehicle's owner, you are responsible for the safe and proper operation of your motorcycle.

Motorcycles are single-track vehicles. Their safe use and operation are dependent upon the use of proper riding techniques as well as the expertise of the operator. Every operator should know the following requirements before riding this motorcycle.

He or she should:

- Obtain thorough instructions from a competent source on all aspects of motorcycle operation.
- Observe the warnings and maintenance requirements in this Owner's Manual.
- Obtain qualified training in safe and proper riding techniques.
- Obtain professional technical service as indicated in this Owner's Manual and/or when made necessary by mechanical conditions.

- Never operate a motorcycle without proper training or instruction. Take a training course. Beginners should receive training from a certified instructor. Contact an authorized motorcycle dealer to find out about the training courses nearest you.

Safe Riding

Perform the pre-operation checks each time you use the vehicle to make sure it is in safe operating condition. Failure to inspect or maintain the vehicle properly increases the possibility of an accident or equipment damage. See page 6-1 for a list of pre-operation checks.

- This motorcycle is designed to carry the operator and a passenger.
- The failure of motorists to detect and recognize motorcycles in traffic is the predominating cause of automobile/motorcycle accidents. Many accidents have been caused by an automobile driver who did not see the motorcycle. Making yourself conspicuous ap-

pears to be very effective in reducing the chance of this type of accident.

Therefore:

- Wear a brightly colored jacket.
- Use extra caution when you are approaching and passing through intersections, since intersections are the most likely places for motorcycle accidents to occur.
- Ride where other motorists can see you. Avoid riding in another motorist's blind spot.
- Never maintain a motorcycle without proper knowledge. Contact an authorized motorcycle dealer to inform you on basic motorcycle maintenance. Certain maintenance can only be carried out by certified staff.

- Many accidents involve inexperienced operators. In fact, many operators who have been involved in accidents do not even have a current motorcycle license.
 - Make sure that you are qualified and that you only lend your motorcycle to other qualified operators.
 - Know your skills and limits. Staying within your limits may help you to avoid an accident.
 - We recommend that you practice riding your motorcycle where there is no traffic until you have become thoroughly familiar with the motorcycle and all of its controls.
- Many accidents have been caused by error of the motorcycle operator. A typical error made by the operator is veering wide on a turn due to excessive speed or undercornering (insufficient lean angle for the speed).
 - Always obey the speed limit and never travel faster than warranted by road and traffic conditions.
- Always signal before turning or changing lanes. Make sure that other motorists can see you.
- The posture of the operator and passenger is important for proper control.
 - The operator should keep both hands on the handlebar and both feet on the operator footrests during operation to maintain control of the motorcycle.
 - The passenger should always hold onto the operator, the seat strap or grab bar, if equipped, with both hands and keep both feet on the passenger footrests. Never carry a passenger unless he or she can firmly place both feet on the passenger footrests.
- Never ride under the influence of alcohol or other drugs.
- This motorcycle is designed for on-road use only. It is not suitable for off-road use.

Protective Apparel

The majority of fatalities from motorcycle accidents are the result of head injuries. The use of a safety helmet is the single most critical factor in the prevention or reduction of head injuries.

- Always wear an approved helmet.
- Wear a face shield or goggles. Wind in your unprotected eyes could contribute to an impairment of vision that could delay seeing a hazard.
- The use of a jacket, heavy boots, trousers, gloves, etc., is effective in preventing or reducing abrasions or lacerations.
- Never wear loose-fitting clothes, otherwise they could catch on the control levers, footrests, or wheels and cause injury or an accident.
- Always wear protective clothing that covers your legs, ankles, and feet. The engine or exhaust system become very hot during or after operation and can cause burns.
- A passenger should also observe the above precautions.

Safety information

2

Avoid Carbon Monoxide Poisoning

All engine exhaust contains carbon monoxide, a deadly gas. Breathing carbon monoxide can cause headaches, dizziness, drowsiness, nausea, confusion, and eventually death.

Carbon Monoxide is a colorless, odorless, tasteless gas which may be present even if you do not see or smell any engine exhaust. Deadly levels of carbon monoxide can collect rapidly and you can quickly be overcome and unable to save yourself. Also, deadly levels of carbon monoxide can linger for hours or days in enclosed or poorly ventilated areas. If you experience any symptoms of carbon monoxide poisoning, leave the area immediately, get fresh air, and **SEEK MEDICAL TREATMENT.**

- Do not run engine indoors. Even if you try to ventilate engine exhaust with fans or open windows and doors, carbon monoxide can rapidly reach dangerous levels.
- Do not run engine in poorly ventilated or partially enclosed areas such as barns, garages, or carports.

- Do not run engine outdoors where engine exhaust can be drawn into a building through openings such as windows and doors.

Loading

Adding accessories or cargo to your motorcycle can adversely affect stability and handling if the weight distribution of the motorcycle is changed. To avoid the possibility of an accident, use extreme caution when adding cargo or accessories to your motorcycle. Use extra care when riding a motorcycle that has added cargo or accessories. Here, along with the information about accessories below, are some general guidelines to follow if loading cargo to your motorcycle:

The total weight of the operator, passenger, accessories and cargo must not exceed the maximum load limit.

Operation of an overloaded vehicle could cause an accident.

Maximum load:
166 kg (366 lb)

When loading within this weight limit, keep the following in mind:

- Cargo and accessory weight should be kept as low and close to the motorcycle as possible. Securely pack your heaviest items as close to the center of the vehicle as possible and make sure to distribute the weight as evenly as possible on both sides of the motorcycle to minimize imbalance or instability.
- Shifting weights can create a sudden imbalance. Make sure that accessories and cargo are securely attached to the motorcycle before riding. Check accessory mounts and cargo restraints frequently.
- Properly adjust the suspension for your load (suspension-adjustable models only), and check the condition and pressure of your tires.
- Never attach any large or heavy items to the handlebar, front fork, or front fender. These items, including such cargo as sleeping bags, duffel bags, or

tents, can create unstable handling or a slow steering response.

- **This vehicle is not designed to pull a trailer or to be attached to a sidecar.**

Genuine Yamaha Accessories

Choosing accessories for your vehicle is an important decision. Genuine Yamaha accessories, which are available only from a Yamaha dealer, have been designed, tested, and approved by Yamaha for use on your vehicle.

Many companies with no connection to Yamaha manufacture parts and accessories or offer other modifications for Yamaha vehicles. Yamaha is not in a position to test the products that these aftermarket companies produce. Therefore, Yamaha can neither endorse nor recommend the use of accessories not sold by Yamaha or modifications not specifically recommended by Yamaha, even if sold and installed by a Yamaha dealer.

Aftermarket Parts, Accessories, and Modifications

While you may find aftermarket products similar in design and quality to genuine Yamaha accessories, recognize that some aftermarket accessories or modifications are not suitable because of potential safety hazards to you or others. Installing aftermarket products or having other modifications performed to your vehicle that change any of the vehicle's design or operation characteristics can put you and others at greater risk of serious injury or death. You are responsible for injuries related to changes in the vehicle.

Keep the following guidelines in mind, as well as those provided under "Loading" when mounting accessories.

- Never install accessories or carry cargo that would impair the performance of your motorcycle. Carefully inspect the accessory before using it to make sure that it does not in any way reduce ground clearance or cornering clearance, limit suspension travel,

steering travel or control operation, or obscure lights or reflectors.

- Accessories fitted to the handlebar or the front fork area can create instability due to improper weight distribution or aerodynamic changes. If accessories are added to the handlebar or front fork area, they must be as lightweight as possible and should be kept to a minimum.
- Bulky or large accessories may seriously affect the stability of the motorcycle due to aerodynamic effects. Wind may attempt to lift the motorcycle, or the motorcycle may become unstable in cross winds. These accessories may also cause instability when passing or being passed by large vehicles.
- Certain accessories can displace the operator from his or her normal riding position. This improper position limits the freedom of movement of the

Safety information

2

operator and may limit control ability, therefore, such accessories are not recommended.

- Use caution when adding electrical accessories. If electrical accessories exceed the capacity of the motorcycle's electrical system, an electric failure could result, which could cause a dangerous loss of lights or engine power.

Aftermarket Tires and Rims

The tires and rims that came with your motorcycle were designed to match the performance capabilities and to provide the best combination of handling, braking, and comfort. Other tires, rims, sizes, and combinations may not be appropriate. See page 8-15 for tire specifications and for information on servicing and replacing your tires.

Transporting the Motorcycle

Be sure to observe following instructions before transporting the motorcycle in another vehicle.

- Remove all loose items from the motorcycle.
- Check that the fuel cock (if equipped) is in the off position and that there are no fuel leaks.
- Shift the transmission into gear (for models with a manual transmission).
- Secure the motorcycle with tie-downs or suitable straps that are attached to solid parts of the motorcycle, such as the frame or upper front fork triple clamp (and not, for example, to rubber-mounted handlebars or turn signals, or parts that could break). Choose the location for the straps carefully so the straps will not rub against painted surfaces during transport.
- The suspension should be compressed somewhat by the tie-downs, if possible, so that the motorcycle will not bounce excessively during transport.

EAUJ0033

Helmets

Operating this vehicle without an approved motorcycle helmet increases your chances of a severe head injury or death in the event of an accident. The majority of fatalities from motorcycle or scooter accidents are the result of head injuries. The use of a safety helmet is the single most critical factor in the prevention or reduction of head injuries.

Always select an approved motorcycle helmet

Pay attention to the following when choosing a motorcycle helmet.

- The helmet must meet the safety standard "TIS".
- The helmet size must match the size of the rider's head.
- Never subject a helmet to heavy shocks.

Wearing the helmet correctly

Always connect the chin strap. In the case of an accident, the helmet has a much less chance of coming off if the chin strap is connected.

Correct usage



ZAUU0003

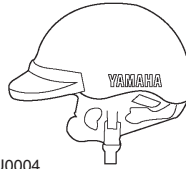

ZAUU0004



ZAUU0006

Wrong usage



ZAUU0007



ZAUU0005

- Full-type: use only for riding at low to mid-range speeds

Types of helmets and their usage

- Half-type: use only for riding at low speeds

- Full-face-type: use for riding at mid-range to high speeds

Description

EAU10411

Left view

3

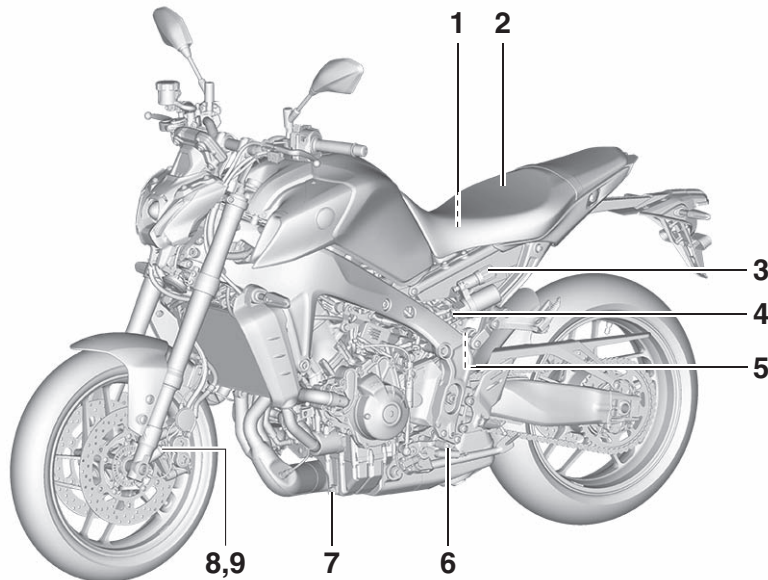

1. Battery (page 8-28)

2. Seat (page 5-24)

3. Spring preload adjuster (page 5-28)

4. Compression damping force adjuster (page 5-28)

5. Rebound damping force adjuster (page 5-28)

6. Shift pedal (page 5-18)

7. Engine oil drain bolt (page 8-10)

8. Fast compression damping force adjuster (page 5-25)

9. Slow compression damping force adjuster (page 5-25)

Right view

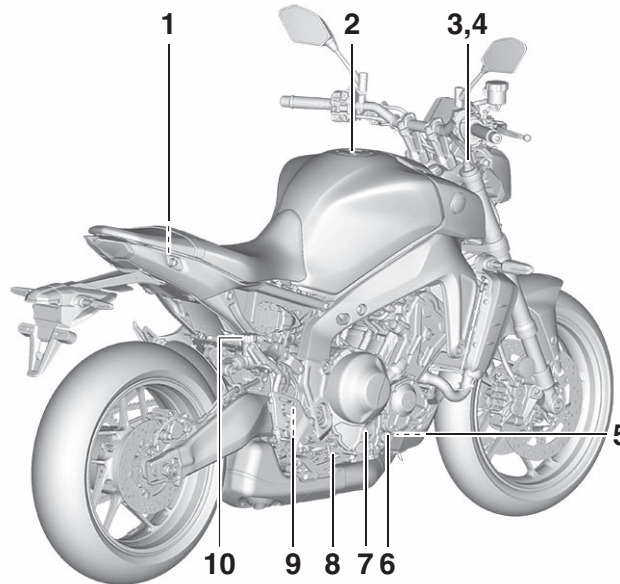

1. Fuses (page 8-30)
2. Fuel tank cap (page 5-21)
3. Spring preload adjuster (page 5-25)
4. Rebound damping force adjuster (page 5-25)
5. Coolant reservoir (page 8-13)
6. Engine oil level check window (page 8-10)
7. Engine oil filler cap (page 8-10)
8. Brake pedal (page 5-19)

9. Rear brake light switch (page 8-19)
10. Rear brake fluid reservoir (page 8-20)

Controls and instruments

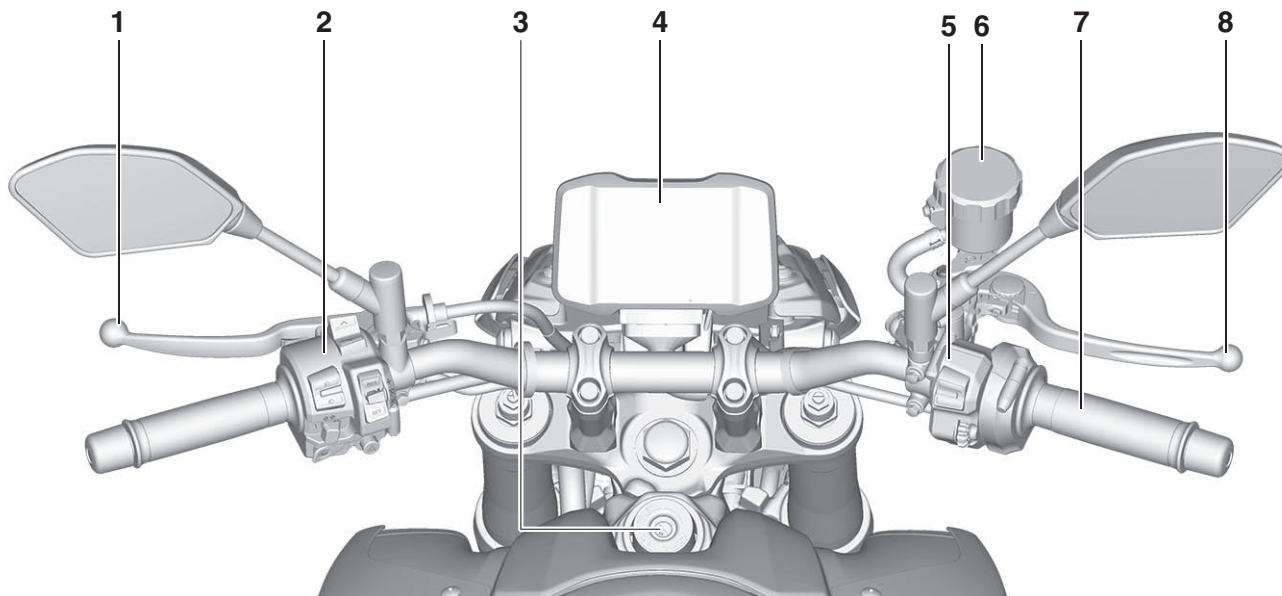
3

1. Clutch lever (page 5-18)
2. Left handlebar switches (page 5-3)
3. Main switch/steering lock (page 5-2)
4. Instrument panel (page 5-5, 5-8)
5. Right handlebar switches (page 5-3)
6. Front brake fluid reservoir (page 8-20)
7. Throttle grip (page 8-25)
8. Brake lever (page 5-19)

Cruise control system

EAU91733

This model is equipped with a cruise control system designed to maintain a set cruising speed.

The cruise control system operates only when riding in 4th, 5th or 6th gear at speeds between about 50 km/h (31 mi/h) and 180 km/h (112 mi/h).

EWA21140

WARNING

- **Improper use of the cruise control system may result in loss of control, which could lead to an accident. Do not activate the cruise control system in heavy traffic, poor weather conditions, or among winding, slippery, hilly, rough or gravel roads.**
- **When traveling uphill or downhill, the cruise control system may not be able to maintain the set cruising speed.**
- **To prevent accidentally activating the cruise control system, turn it off when not in use. Make sure that the cruise control system indicator light “The image shows a close-up of the instrument cluster. On the left side, there are several indicator lights: a red light with a minus sign, a green light with a plus sign, a yellow light with a 'CC' symbol, a green light with 'SET', a yellow light with a car icon, a red light with a triangle, and a yellow light with a car icon. On the right side, there is a speedometer showing a speed of 108 km/h. Below the speedometer, there are indicators for TCS-mode (1) and D-mode (1). The time 10:00 and a battery level indicator are also visible.**

1. Cruise control setting indicator light “The image shows a close-up of the cruise control control panel on the handlebar. It features three main controls: a 'RES+' button (labeled 1), a power switch with a 'CC' symbol (labeled 2), and a 'SET-' button (labeled 3). There are also some other buttons like 'PASS' and 'DUAL' visible.

1. Cruise control setting switch “RES+”
2. Cruise control power switch “

Activating and setting the cruise control system

1. Press the cruise control power switch “

Adjusting the set cruising speed

While the cruise control system is operating, press the “RES+” side of the cruise control setting switch to increase the set cruising speed or the “SET-” side to decrease the set speed.

TIP

Pressing the setting switch once will change the speed in increments of approximately 2.0 km/h (1.2 mi/h). Holding the “RES+” or “SET-” side of the

Special features

cruise control setting switch down will increase or decrease the speed continuously until the switch is released.

You can also manually increase your traveling speed using the throttle. After you have accelerated, you can set a new cruising speed by pressing the “SET-” side of the setting switch. If you do not set a new cruising speed, when you return the throttle, the vehicle will decelerate to the previously set cruising speed.

Deactivating the cruise control system

Perform one of the following operations to cancel the set cruising speed. The “RES+” indicator light will go off.

- Turn the throttle grip past the closed position in the deceleration direction.

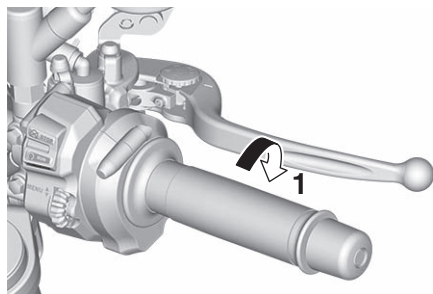

1. Deceleration direction

- Apply the front or rear brake.
- Disengage the clutch.
- Shift gears

Press the power switch to turn off the cruise control system. The “RES+” indicator light and the “SET-” indicator light will go off.

TIP

Traveling speed decreases as soon as the cruise control system is deactivated; unless the throttle grip is turned.

Using the resume function

Press the “RES+” side of the cruise control setting switch to reactivate the cruise control system. The traveling

speed will return to the previously set cruising speed. The “RES+” indicator light will come on.

EWA16351

WARNING

It is dangerous to use the resume function when the previously set cruising speed is too high for current conditions.

TIP

Pressing the power switch while the system is operating will turn the system off completely and erase the previously set cruising speed. You will not be able to use the resume function until a new cruising speed has been set.

Automatic deactivation of the cruise control system

The cruise control system for this model is electronically controlled and is linked with the other control systems. The cruise control system will automatically become deactivated under the following conditions:

- The cruise control system is not able to maintain the set cruising speed.

“D-MODE”

“D-MODE” is an electronically controlled engine performance system.

WARNING

Do not change the drive mode while the vehicle is moving.



The “D-MODE” system consists of 4 different control maps which regulate engine response and output, thus providing you with a selection of modes to fit your preferences and the riding environment.



- D-MODE 1** - Sporty engine response
- D-MODE 2** - Moderate engine response
- D-MODE 3** - Mild engine response
- D-MODE 4** - Mild engine response and limits engine output

TIP

- The current “D-MODE” setting is shown in the MODE display. (See page 5-11.)
- The current “D-MODE” setting is saved when the vehicle is turned off.

- Wheel slip or wheel spin is detected. (If the traction control system has not been turned off, the traction control system will work.)
- The start/engine stop switch is set to the “” position.
- The engine stalls.
- The sidestand is lowered.

When traveling with a set cruising speed, if the cruise control system is deactivated under the above conditions, the “” indicator light will go off and the “” indicator light will flash for 4 seconds, and then go off.

When not traveling with a set cruising speed, if the start/engine stop switch is set to the “” position, the engine stalls, or the sidestand is lowered, then the “” indicator light will go off (the “” indicator light will not flash). If the cruise control system is automatically deactivated, please stop and confirm that your vehicle is in good operating condition.

Before using the cruise control system again, activate it using the power switch.

TIP

In some cases, the cruise control system may not be able to maintain the set cruising speed when the vehicle is traveling uphill or downhill.

- When the vehicle is traveling uphill, the actual traveling speed may become lower than the set cruising speed. If this occurs, accelerate to the desired traveling speed using the throttle.
- When the vehicle is traveling downhill, the actual traveling speed may become higher than the set cruising speed. If this occurs, the setting switch cannot be used to adjust the set cruising speed. To reduce the traveling speed, apply the brakes. When the brakes are applied, the cruise control system will become deactivated.

Special features

- The “D-MODE” is controlled by the MODE switches, see page 5-4 for more information.

4

“TCS-MODE”

EAU91434

This model is equipped with the traction control system, the slide control system (SCS), and the lift control system (LIF). These are grouped together into “TCS-MODE”. “TCS-MODE” has 4 settings:

MODE	Traction control system	SCS	LIF
TCS-MODE 1	1	1	1
TCS-MODE 2	2	2	2
TCS-MODE M	1, 2, 3	OFF, 1, 2, 3	OFF, 1, 2, 3
TCS-MODE OFF	OFF	OFF	OFF

“TCS-MODE M” is customizable in the settings MENU, see page 5-14.

Traction control system

The traction control system helps maintain traction when accelerating. If sensors detect that the rear wheel is starting to slip (uncontrolled spinning), the traction control system assists by regulating engine power as needed until traction is restored. The stability

control indicator light “**SC**” flashes to let the rider know that traction control has engaged.

This traction control system automatically adjusts according to the vehicle’s lean angle. To maximize acceleration, when the vehicle is upright a lesser amount of traction control is applied. When cornering, a greater amount of traction control is applied.



Traction control system

TIP

- The traction control system may engage when the vehicle travels over a bump.
- You may notice slight changes in engine and exhaust sounds when the traction control or other systems engage.

- The traction control system can only be turned off by setting “TCS-MODE” to “OFF”, using the MODE switches. See page 5-4 for more information on “TCS-MODE”.
- When “TCS-MODE” has been set to “OFF”, the traction control system, SCS and LIF systems are all turned off together.

EWA15433

WARNING

The traction control system is not a substitute for riding appropriately for the conditions. Traction control cannot prevent loss of traction due to excessive speed when entering turns, when accelerating hard at a sharp lean angle, or while braking, and cannot prevent front wheel slipping. As with any vehicle, approach surfaces that may be slippery with caution and avoid especially slippery surfaces.

When the vehicle power is on, the traction control system automatically turns on. The traction control system can be

turned on or off manually only when the key is in the “ON” position and the motorcycle is stopped.

TIP

Set “TCS-MODE” to “OFF” to help free the rear wheel if the motorcycle gets stuck in mud, sand, or other soft surfaces.

ECA16801

NOTICE

Use only the specified tires. (See page 8-15.) Using different sized tires will prevent the traction control system from controlling tire rotation accurately.

SCS

The slide control system regulates engine power output when a sideward slide is detected in the rear wheel. It adjusts power output based on data from the IMU (Inertial Measurement Unit). This system supports the traction control system to contribute to a smoother ride.

LIF

The lift control system reduces the rate at which the front wheel rises during extreme acceleration, such as during starts or out-of-corner exits. When front-wheel lift is detected, engine power is regulated to slow front-wheel lift while still providing good acceleration.

Special features

EAU91341

Quick shifter

The quick shifter allows for clutch lever-less, electronically-assisted shifting. When the sensor on the shift rod detects the appropriate motion in the shift pedal, engine power output is momentarily adjusted to allow for the gear change to occur.

The quick shifter does not operate when the clutch lever is pulled, therefore normal shifting can be done even when the quick shifter is set to on. Check the quick shifter indicator for current status and usability information.

Quick shifter usability	Indicator
Upshifting OK	QS ▲▼
Downshifting OK	QS ▲▼
Quick shifter cannot be used	QS ▲▼
Quick shifter turned off	QS ▲▼

Upshifting conditions

- Vehicle speed of at least 20 km/h (12 mi/h)
- Engine speed of at least 2200 r/min
- Accelerating (open throttle)

Downshifting conditions

- Vehicle speed of at least 20 km/h (12 mi/h)
- Engine speed of at least 2000 r/min
- Engine speed sufficiently away from red zone
- Decelerating and throttle fully-closed

TIP

- QS ▲ and QS ▼ can be individually set.
- Shifting into or out of neutral must be done using the clutch lever.

EAU91350

BC

The brake control system regulates hydraulic brake pressure for the front and rear wheels when the brakes are applied and wheel lock is detected. This system has two settings.

BC1 is standard ABS, which adjusts brake pressure based on vehicle speed and wheel speed data. BC1 is designed to engage and maximize braking when the vehicle is upright.

BC2 uses additional data from the IMU to regulate applied brake power when cornering to suppress lateral wheel slip.

BC1/BC2



BC2



BC2



ABS

EWA20891

 **WARNING**

The brake control system is not a substitute for the use of proper riding and braking techniques. The brake control system cannot prevent all loss of traction due to over-braking from excessive speed, or lateral wheel slip when braking on slippery surfaces.

Instrument and control functions

Immobilizer system

EAU1097B

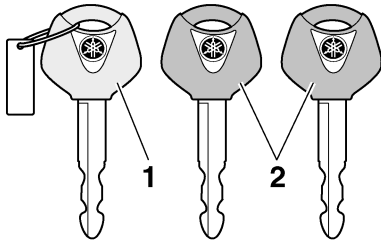

1. Code re-registering key (red bow)
2. Standard keys (black bow)

This vehicle is equipped with an immobilizer system to help prevent theft by re-registering codes in the standard keys. This system consists of the following:

- a code re-registering key
- two standard keys
- a transponder (in each key)
- an immobilizer unit (on the vehicle)
- an ECU (on the vehicle)
- a system indicator light (page 5-7)

About the keys

The code re-registering key is used to register codes in each standard key. Store the code re-registering key in a safe place. Use a standard key for daily operation.

When key replacement or re-registering is necessary, bring the vehicle and the code re-registering key along with any remaining standard keys to a Yamaha dealer to have them re-registered.

TIP

- Keep the standard keys as well as keys of other immobilizer systems away from the code re-registering key.
- Keep other immobilizer system keys away from the main switch as they may cause signal interference.

ECA11823

NOTICE

DO NOT LOSE THE CODE RE-REGISTERING KEY! CONTACT YOUR DEALER IMMEDIATELY IF IT IS LOST! If the code re-registering key is lost, the existing standard keys

can still be used to start the vehicle. However, registering a new standard key is impossible. If all keys have been lost or damaged, the entire immobilizer system must be replaced. Therefore, handle the keys carefully.

- Do not submerge in water.
- Do not expose to high temperatures.
- Do not place near magnets.
- Do not place near items that transmit electrical signals.
- Do not handle roughly.
- Do not grind or alter.
- Do not disassemble.
- Do not put two keys of any immobilizer system on the same key ring.

Main switch/steering lock

EAU10474

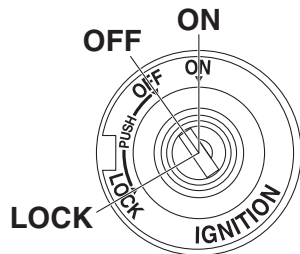

The main switch/steering lock controls the ignition and lighting systems, and is used to lock the steering. The various positions are described below.

TIP

Be sure to use the standard key (black bow) for regular use of the vehicle. To minimize the risk of losing the code re-registering key (red bow), keep it in a safe place and only use it for code re-registering.

ON

All electrical circuits are supplied with power and the vehicle lights are turned on. The engine can be started. The key cannot be removed.

TIP

- The headlight(s) will turn on when the engine is started.
- To prevent battery drain, do not leave the key in the "ON" position without the engine running.

OFF

All electrical systems are off. The key can be removed.

⚠ WARNING

Never turn the key to "OFF" or "LOCK" while the vehicle is moving. Otherwise the electrical systems will be switched off, which may result in loss of control or an accident.

EAU84035

LOCK

The steering is locked and all electrical systems are off. The key can be removed.

To lock the steering

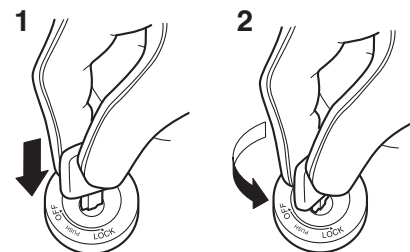

1. Push.
2. Turn.

1. Turn the handlebars all the way to the left.
2. With the key in the "OFF" position, push the key in and turn it to "LOCK".
3. Remove the key.

Instrument and control functions

TIP _____
If the steering will not lock, try turning the handlebars back to the right slightly.

To unlock the steering

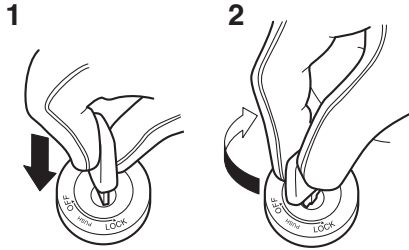

Push the key in and turn it to “OFF”.

Handlebar switches

EAU66057

Left

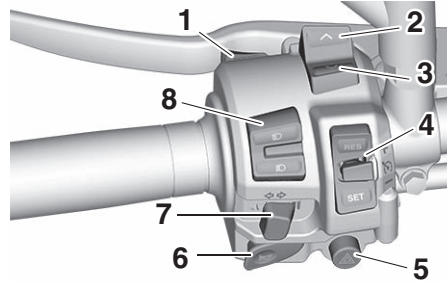

1. “MODE” switch
2. MODE up switch
3. MODE down switch
4. Cruise control switches
5. Hazard switch “ \triangle ”
6. Horn switch “ HORN ”
7. Turn signal switch “ \leftarrow/\rightarrow ”
8. Dimmer/Pass switch “ $\equiv\text{O}/\equiv\text{O}/\text{PASS}$ ”

Right

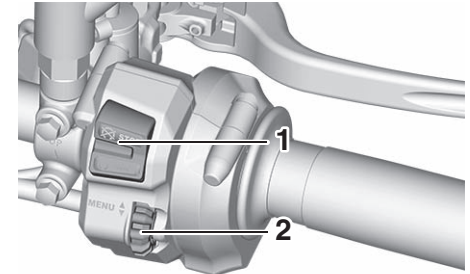

1. Stop/Run/Start switch “ $\text{X}/\text{O}/\text{S}$ ”
2. Wheel switch “MENU \blacklozenge ”

Dimmer/Pass switch “ $\equiv\text{O}/\equiv\text{O}/\text{PASS}$ ”

EAU91630

Set this switch to “ $\equiv\text{O}$ ” for the high beam and to “ $\equiv\text{O}$ ” for the low beam. While the headlight is set on low beam, push the switch down towards “PASS” to flash the high beam and to mark the start of each lap when using the lap timer.

Turn signal switch “ \leftarrow/\rightarrow ”

EAU66040

To signal a right-hand turn, push this switch to “ \rightarrow ”. To signal a left-hand turn, push this switch to “ \leftarrow ”. When released, the switch returns to the cen-

ter position. To cancel the turn signal lights, push the switch in after it has returned to the center position.



Horn switch “”

EAU66030

Press this switch to sound the horn.

Stop/Run/Start switch “”

EAU66061

To crank the engine with the starter, set this switch to “”, and then push the switch down towards “”. See page 7-2 for starting instructions prior to starting the engine.

Set this switch to “” to stop the engine in case of an emergency, such as when the vehicle overturns or when the throttle cable is stuck.

Hazard switch “”

EAU91670

Use this switch to turn on the hazard lights (simultaneous flashing of all turn signal lights). The hazard lights are used in case of an emergency or to warn other drivers when your vehicle is stopped where it might be a traffic hazard.

The hazard lights can be turned on or off only when the key is in the “ON” position. You can turn the main switch to the “OFF” or “LOCK” position, and the hazard lights will continue to flash. To turn off the hazard lights, turn the main switch to the “ON” position and operate the hazard switch again.

NOTICE

Do not use the hazard lights for an extended length of time with the engine not running, otherwise the battery may discharge.

ECA10062

Cruise control switches

See page 4-1 for an explanation of the cruise control system.

EAU73952

MODE switches

Use the MODE switches to change the “D-MODE” and “TCS-MODE” located on the left side of the main display.

There are three mode controls:

MODE up switch - press this switch to change the selected mode setting upward.

EAU91365

“MODE” switch - press this switch to toggle left to right between “D-MODE” and “TCS-MODE”.

MODE down switch - press this switch to change the selected mode setting downward.

TIP

- When in “D-MODE 1”, pressing the MODE up switch will cycle to “D-MODE 4”. When in “D-MODE 4”, pressing the MODE down switch will not cycle to “D-MODE 1”.
- The “TCS-MODE” can only be turned off from the main display. Select “TCS-MODE” with the “MODE” switch, then press and hold the MODE up switch until “OFF” is displayed.
- To turn the traction control system back on, use the MODE down switch.
- When “TCS-MODE” has been set to “OFF”, the traction control system, SCS and LIF systems are all turned off together.
- See page 5-11 for more information on the MODE display.

Instrument and control functions

- See page 4-4 for more information on “TCS-MODE”.
- See page 4-3 for more information on “D-MODE”.

EAU91374

Wheel switch “MENU”

When the wheel switch is operated, a cursor will appear around the previously selected item on the display.

The wheel switch controls:

- Vehicle information displays
- Settings MENU
- Grip warmer function (Option)

Operate the wheel switch as follows:

Rotate up - rotate the wheel upward to scroll up or increase a setting value.

Rotate down - rotate the wheel downward to scroll down or decrease a setting value.

Press inward - press the wheel switch in towards the handlebar to select items indicated by the cursor and confirm settings changes. Press and hold the switch inward to reset selected items.

TIP

- If the wheel switch is not operated for a certain period of time, the cursor will disappear.
- For items that can be reset, leave the cursor over the item, press and hold the switch to reset.
- See page 5-8 for more information on the main screen and its functions.
- See page 5-13 for more information on the MENU screen and how to make settings changes.

Indicator lights and warning lights

EAU4939X

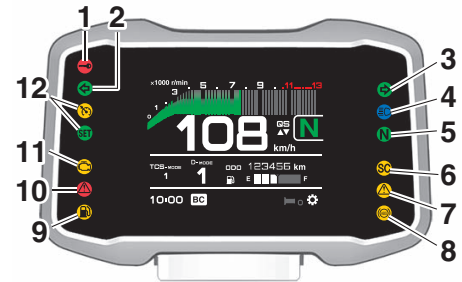

1. Immobilizer system indicator light “”
2. Left turn signal indicator light “”
3. Right turn signal indicator light “”
4. High beam indicator light “”
5. Neutral indicator light “”
6. Stability control indicator light “”
7. Auxiliary system warning light “”
8. ABS warning light “”
9. Fuel level warning light “”
10. Oil pressure and Coolant temperature warning light “”
11. Engine trouble warning light “”
12. Cruise control indicator lights “” / “”

Turn signal indicator lights “” and “”

EAU88280

Each indicator light will flash when its corresponding turn signal lights are flashing.

Neutral indicator light “”

EAU88300

This indicator light comes on when the transmission is in the neutral position.

High beam indicator light “”

EAU88310

This indicator light comes on when the high beam of the headlight is switched on.

Fuel level warning light “”

EAU88320

This warning light comes on when the fuel level drops below approximately 2.8 L (0.74 US gal, 0.62 Imp.gal). When this occurs, refuel as soon as possible. The electrical circuit of the warning light can be checked by turning the vehicle on. The warning light should come on for a few seconds, and then go off.

TIP _____

If the warning light does not come on at all, remains on after refueling, or if the warning light flashes repeatedly, have a Yamaha dealer check the vehicle.

Cruise control indicator lights “”/“”

EAU91650

These indicator lights come on when the cruise control system is activated. (See page 4-1.)

TIP _____

When the vehicle is turned on, these lights should come on for a few seconds and then go off. Otherwise, have a Yamaha dealer check the vehicle.

Engine trouble warning light “”

EAU88550

This warning light comes on if a problem is detected in the engine. If this occurs, have a Yamaha dealer check the on-board diagnostic system.

TIP _____

When the vehicle is turned on, this light should come on for a few seconds and then go off. Otherwise, have a Yamaha dealer check the vehicle.

ABS warning light “”

EAU91500

In normal operation, the ABS warning light comes on when the vehicle is turned on, and goes off after traveling at a speed of 5 km/h (3 mi/h) or higher.

TIP _____

If the warning light does not work as described above, or if the warning light comes on while riding, the ABS may not work correctly. Have a Yamaha dealer check the vehicle as soon as possible.

WARNING _____

EWA21120

If the ABS warning light does not turn off after reaching 5 km/h (3 mi/h), or if the warning light comes on while riding:

- Use extra caution to avoid possible wheel lock during emergency braking.

Instrument and control functions

- **Have a Yamaha dealer check the vehicle as soon as possible.**

Immobilizer system indicator light “”

EAU88350

When the main switch is turned off and 30 seconds have passed, the indicator light will flash steadily to indicate the immobilizer system is enabled. After 24 hours have passed, the indicator light will stop flashing, however the immobilizer system is still enabled.

TIP

When the vehicle is turned on, this light should come on for a few seconds and then go off. If the light does not come on, or if the light remains on, have a Yamaha dealer check the vehicle.

Transponder interference

If the immobilizer system indicator light flashes in the pattern, slowly 5 times then quickly 2 times, this could be caused by transponder interference. If this occurs, try the following.

1. Make sure there are no other immobilizer keys close to the main switch.
2. Use the code re-registering key to start the engine.
3. If the engine starts, turn it off, and try starting the engine with the standard keys.
4. If one or both of the standard keys do not start the engine, take the vehicle and all 3 keys to a Yamaha dealer to have the standard keys re-registered.

Stability control indicator light “”

EAU91472

This indicator light flashes when the traction control system, SCS, or LIF systems engage while riding. When “TCS-MODE” is set to “OFF”, the indicator will come on.

TIP

When the vehicle is turned on, this light should come on for a few seconds and then go off. If the light does not come on, or if the light remains on, have a Yamaha dealer check the vehicle.

ECA27222

NOTICE

When turning the main switch on, avoid any movement or vibration of the vehicle as it may interfere with the initialization of the IMU. If this occurs, the traction control system will not operate and the “TCS-MODE” display will read “OFF” until the IMU can initialize.

EAU88362

Oil pressure and Coolant temperature warning light “”

This warning light comes on if the engine oil pressure is low or if the coolant temperature is high. If this occurs, stop the engine immediately.

TIP

- When the vehicle is first turned on, this light should come on until the engine is started.
- If a malfunction is detected, this light will come on and the oil pressure icon will flash.

ECA22441

NOTICE

If the oil pressure and coolant warning light does not go off after starting the engine or if it comes on while the engine is running, stop the vehicle and engine immediately.

- If the engine is overheating, the coolant temperature warning icon will come on. Let the engine cool. Check the coolant level (see page 8-35).
- If the engine oil pressure is low, the oil pressure warning icon will come on. Check the oil level (see page 8-10).
- If the warning light remains on after letting the engine cool and confirming the proper oil level, have a Yamaha dealer check the vehicle. Do not continue to operate the vehicle!

EAU88370

Auxiliary system warning light “”

This warning light comes on if a problem is detected in a non-engine-related system.

TIP

When the vehicle is turned on, this light should come on for a few seconds and then go off. Otherwise, have a Yamaha dealer check the vehicle.

EAU92302

Display

The following items can be found on the display:

Instrument and control functions

5

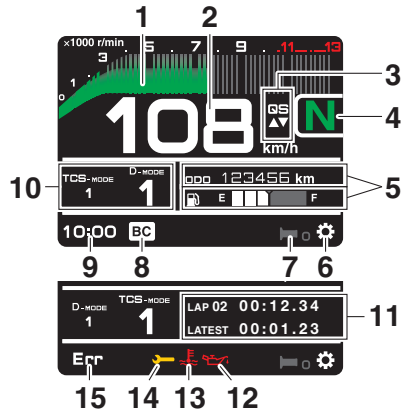

1. Tachometer
2. Speedometer
3. Quick shifter indicator “QS”
4. Transmission gear display
5. Vehicle information displays
6. Settings MENU icon “⚙️”
7. Grip warmer indicator (option)
8. Brake control icon “BC”
9. Clock
10. MODE display
11. Lap timer
12. Oil pressure warning “”
13. Coolant temperature warning “”
14. Auxiliary system warning “”
15. Error mode warning “Err” (replaces clock when activated)

TIP

This model uses a thin-film-transistor liquid-crystal display (TFT LCD) for good contrast and readability in various lighting conditions. However, due to the nature of this technology, it is normal for a small number of pixels to be inactive.

WARNING

Stop the vehicle before making any setting changes. Changing settings while riding can distract the operator and increase the risk of an accident.

Speedometer

The speedometer shows the vehicle’s traveling speed.

TIP

The display can be switched between kilometers and miles. See “Unit” on page 5-17.

Tachometer

The tachometer shows the engine speed, as measured by the rotational velocity of the crankshaft, in revolutions per minute (r/min).

ECA10032

NOTICE

Do not operate the engine in the tachometer red zone.

Red zone: 10600 r/min and above

Vehicle information displays

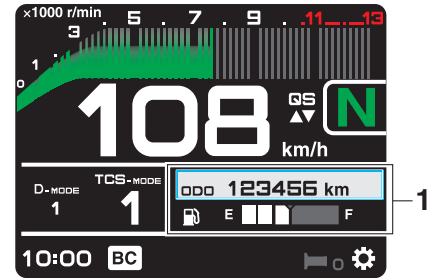

1. Vehicle information displays

The two vehicle information displays can be individually set to show the following items:

- ODO: odometer
- F-TRIP: fuel reserve tripmeter
- TRIP1: tripmeter

- TRIP2: tripmeter
- F.AVE: average fuel economy
- F.CRNT: instantaneous fuel economy
- A.TEMP: air temperature
- C.TEMP: coolant temperature
- Fuel meter
- FUELCON: amount of fuel consumed
- TRIPTIME: running time

Operate the vehicle information display as follows:

Rotate the wheel switch to move the cursor over a display.

Push the wheel switch inward and the selected display will highlight grey.

Rotate the wheel switch to choose a different display item.

Push the wheel switch inward to confirm the new display item.

TIP

- ODO will lock at 999999 and cannot be reset.
- TRIP1 and TRIP2 will reset to 0 and begin counting again after 9999.9 has been reached.

- When the fuel tank reserve level has been reached, F-TRIP appears automatically and begins recording distance traveled from that point.
- After refueling and traveling some distance, F-TRIP will automatically disappear.
- See “Unit” on page 5-17 to change the fuel consumption units.
- The air temperature is displayed from -9°C (16°F) to 50°C (122°F) in 1°C (1°F) increments.
- The air temperature displayed may vary from the actual ambient temperature.
- In LAP TIME mode, the vehicle information display is replaced by the lap information.
- TRIP1, TRIP2, F-TRIP, F.AVE, FUELCON and TRIPTIME items can be individually reset.
- If the vehicle coolant temperature is below 40°C (104°F) the coolant temperature display will read “Lo”

- If the vehicle coolant temperature is above 124°C (255°F) the coolant temperature display will read “Hi”

To reset information display items

1. Rotate the wheel switch to select one of the two vehicle information displays.
2. Press the wheel switch inward to highlight the information display.
3. Rotate the wheel switch to select the desired information display item.
4. Press and hold the wheel switch inward until the highlighted display item is reset.

Transmission gear display

This shows which gear the transmission is in. This model has 6 gears and a neutral position. The neutral position is indicated by the neutral indicator light “N” and by the transmission gear display “N”.

Instrument and control functions

MODE display

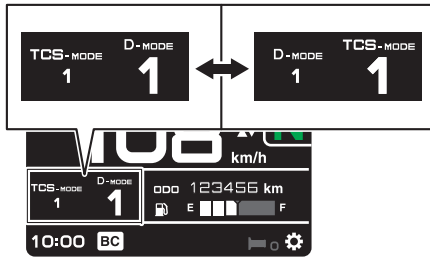

5

This display shows the currently selected “D-MODE” and “TCS-MODE” settings. The mode that is enlarged and displayed on the right can be adjusted using the MODE up/down switches. Use the “MODE” switch to toggle left-right between “TCS-MODE” and “D-MODE”.

See page 4-3 for information on “D-MODE” and “TCS-MODE” settings.

TIP

- When the engine trouble warning light “”, the auxiliary system warning “”, or the coolant temperature warning “” are on, “D-MODE” and “TCS-MODE” cannot be adjusted.

- The previously selected modes will be displayed when the vehicle power is turned on.

To turn off the traction control system, select “TCS-MODE” with the “MODE” switch, then push and hold the MODE up switch until “OFF” is displayed. To turn the traction control system back on, press the MODE down switch (“TCS-MODE” will return to its previous setting).

TIP

- When “TCS-MODE” has been set to “OFF”, the traction control system, SCS and LIF systems are all turned off together.
- The “TCS-MODE OFF” and “TCS-MODE M” settings can only be selected while the vehicle is stopped.

Clock

The clock uses a 12-hour time system. See page 5-17 to set the clock.

Quick shifter indicator “QS”

When able to shift, the respective QS or turns green.

When unable to shift, QS is white.

If the quick shifter function is turned OFF, QS itself is not displayed. The quick shifter functions can be turned on or off in the setting MENU. See page 5-15.

TIP

The upshift and downshift functions are independent and can be activated separately.

For more information on the quick shifter see “Quick shifter” on page 4-6.

Setting menu icon “”

Choose this icon and push the wheel switch to change the settings MENU screen. (See page 5-13.)

Grip warmer indicator (Option)

The grip warmers can be used when the engine is running. There are 10 temperature levels. When activated, the indicator will display the temperature level from 1 (lowest) to 10 (highest).

Instrument and control functions

To activate the grip warmer, use the wheel switch to highlight the grip warmer display with the cursor.

Press the wheel switch inward to select the grip warmer function.

Once selected, rotate the wheel switch up and down to adjust the temperature level.

Press the wheel switch inward to confirm the temperature level and exit the grip warmer function.

ECA17932

NOTICE

- **Be sure to wear gloves when using the grip warmers.**
- **Do not use the grip warmers in warm weather.**
- **If the handlebar grip or throttle grip becomes worn or damaged, stop using the grip warmers and replace the grips.**

The function of the wheel switch can be locked into grip warmer mode by pressing and holding the wheel switch inward while the grip warmer indicator is highlighted by the cursor.

In this mode, the temperature levels can be instantly adjusted by rotating the wheel switch up/down.

To exit this mode and return the wheel switch to its normal functionality, press and hold the wheel switch inward.

TIP

The current grip warmer setting is saved when the vehicle is turned off.

Lap timer

This stopwatch function can be activated through the setting MENU. (See page 5-14.)

Once activated, the vehicle information display is replaced with:



1. Lap count
2. Current lap time
3. Latest/Previous lap time

To start the timer, push the dimmer/pass switch down towards “PASS”.

Each push of the dimmer/pass switch will increase the lap count by 1 and reset the current lap timer.

To pause the lap timer, press the wheel switch inward.

To unpause the timer, push the dimmer/pass switch down towards “PASS” and the timer will resume without counting a new lap.

To exit the lap time mode, turn it off in the settings MENU. (See page 5-14.)

TIP

- The engine must be running to start the lap timer.
- The headlight will flash when the dimmer/pass switch is pressed.
- Whenever the lap timer is paused, it can be resumed using the dimmer/pass switch.

Brake control icon “BC”

This icon is replaced by the auxiliary system warning and coolant temperature warning indicators when they are activated.

Instrument and control functions

For more information on the BC system see “BC” on page 4-6.

Error mode warning “Err”

When an internal error occurs (e.g., communication with a system controller has been cut off), the error mode warning will appear as follows.

“Err” and “

“Err” only indicates an ABS ECU error.

TIP

Depending on the nature of the error, the display may not function properly and the traction control system settings may be impossible to change. Additionally, ABS may not function properly. Use extra care when braking and have a Yamaha dealer check the vehicle immediately.

Auxiliary system warning “ This icon appears if a problem is detected in a non-engine-related system.

Coolant temperature warning “ This icon appears if the coolant temperature reaches 116 °C (241 °F) or higher. Stop the vehicle and turn off the engine. Allow the engine to cool.

ECA10022

NOTICE

Do not continue to operate the engine if it is overheating.

Oil pressure warning “ This icon appears when the engine oil pressure is low. When the vehicle is first turned on, engine oil pressure has yet to build, so this icon will come on and stay on until the engine has been started.

TIP

If a malfunction is detected, the oil pressure warning icon will flash repeatedly.

ECA26410

NOTICE

Do not continue to operate the engine if the oil pressure is low.

Settings MENU

EAU9145B

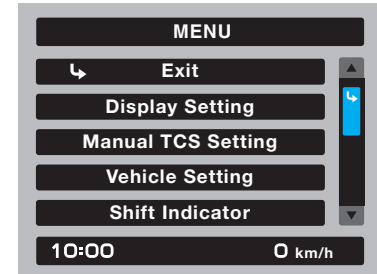

The settings MENU screen contains the following settings modules. Select a module to make related settings changes.

Module	Description
“Exit”	Exit MENU and return the main display
“Display Setting”	Switch lap time mode on/off and adjust the tachometer color
“Manual TCS Setting”	Adjust traction control system/SCS/LIF settings for the “TCS-MODE M”
“Vehicle Setting”	Adjust BC/quick shifter settings
“Shift Indicator”	Turn the shift indicator on/off and adjust tachometer settings
“Maintenance”	View and reset maintenance intervals

Instrument and control functions

“Unit”	Set fuel consumption and measurement units
“Brightness”	Adjust screen brightness
“Clock”	Adjust the clock
“All Reset”	Return all settings to factory default

Settings MENU access and operation

How to use the settings MENU:

Rotate the wheel switch up or down to highlight items or increase/decrease values and briefly press the wheel switch inward to confirm the selection. Press and hold the wheel switch until the screen returns to the main display to exit the MENU at any time.

TIP

- Certain settings menu screens have an upward pointing triangle mark item. Select the triangle mark to save settings changes and exit the current screen.
- Should vehicle motion be detected, the screen will automatically exit the settings MENU and return to the main display.

- To ensure that the desired settings changes are saved, be sure to exit each menu via the triangle mark (if displayed). Exiting the settings menu by pressing and holding the wheel switch may not save settings changes.

“Display Setting”

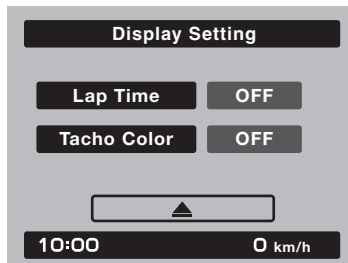

This module allows you to switch the lap time mode and tachometer color mode ON/OFF.

When the lap time mode is selected, the twin vehicle information displays on the main screen will display a lap timer and a lap counter. To exit the lap time mode, the turn lap timer OFF in the display setting module.

To change the tachometer to color mode, select ON.

“Manual TCS Setting”

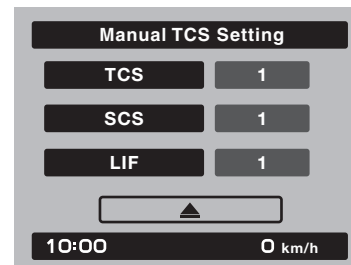

This module allows you to customize the “TCS-MODE M” which is accessible on the main display using the MODE switches.

Traction control system

This model uses a variable traction control system. For each setting level, the further the vehicle is leaned over, the greater the amount of traction control (system intervention) is applied. There are 3 setting levels available for the “TCS-MODE M”.

Instrument and control functions

Setting level 1 applies the least amount of overall system intervention, while setting level 3 applies the greatest amount of overall traction control.

TIP

- The traction control system can only be turned on or off via the main screen using the MODE switches.
- SCS and LIF can be turned off independently of traction control system for “TCS-MODE M”.
- When “TCS-MODE” has been set to “OFF” on the main screen: traction control system, SCS and LIF are all turned off together.

SCS

SCS can be set to OFF, 1, 2, and 3. OFF turns the slide control system off, setting level 1 provides the least amount of system intervention, and setting level 3 provides the greatest amount of system intervention.

LIF

LIF can be set to OFF, 1, 2, and 3.

Setting level 1 provides the least amount of system intervention and setting 3 most strongly reduces the rate of wheel lift.

OFF turns LIF off.

“Vehicle Setting”

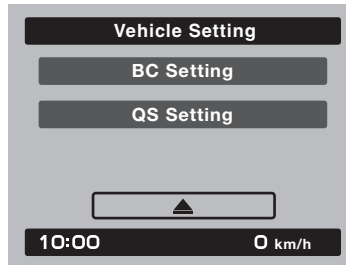

The vehicle setting module allows you to adjust setting for the BC and quick shifter.

BC

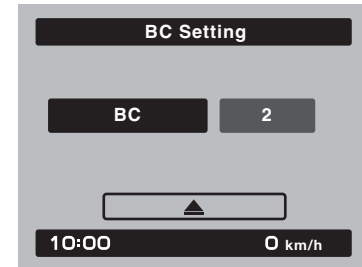

The brake control system has two settings, BC1 and BC2. Select BC1 when only standard ABS is desired. Select BC2 to have the brake control system further regulate brake pressure while cornering to suppress lateral wheel slip.

TIP

For skilled riders and when riding at the track, due to varying conditions, the BC2 brake system may engage sooner than expected relative to your desired cornering speed or intended cornering line.

Instrument and control functions

Quick shifter

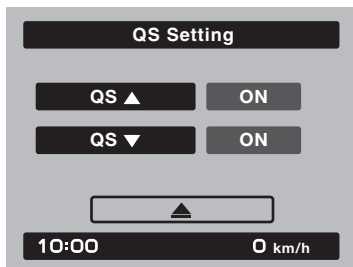

The quick shifter indicators are divided into QS▲ and QS▼ sections. QS▲ and QS▼ are not linked and can be independently turned on or off.

The quick shifter can be set to ON or OFF.

OFF turns the respective upshift or downshift function off, and the clutch lever must then be used when shifting in that direction.

TIP

If the quick shifter setting cannot be changed: turn the engine off with the gear position set to neutral, then change the setting.

“Shift Indicator”

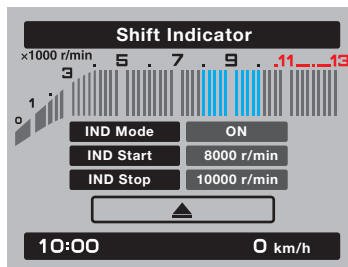

This module allows a custom shift indicator to be set. When the engine r/min (rotations per minute) are in the specified range, the gear indicator will flash.

This module has 3 options:

“IND Mode” - the shift indicator can be turned ON/OFF

“IND Start” - the r/min at which the indicator starts flashing can be chosen.

Once selected, rotate the wheel switch up/down to increase or decrease the r/min value by increments of 200 r/min.

“IND Start” is settable between 6000 - 12800 r/min.

“IND Stop” - the r/min at which the indicator stops flashing can be chosen.

Once selected, rotate the wheel switch up/down to increase or decrease the

r/min value by increments of 200 r/min. “IND Stop” is settable between 6200 - 13000 r/min.

“Maintenance”

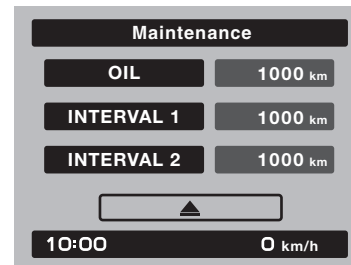

This module allows you to record the distance traveled between engine oil changes (use the OIL item), and for two other items of your choice (use INTERVAL 1 and INTERVAL 2).

To reset a maintenance trip meter, select it and then press and hold the wheel switch.

TIP

Maintenance item names cannot be changed.

Instrument and control functions

“Unit”

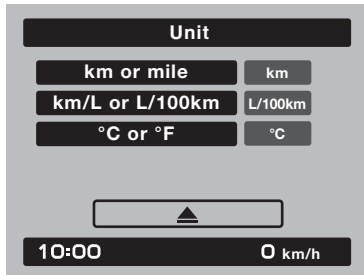

This module allows you to switch the display between metric and imperial measurement units.

When using kilometers, the fuel consumption units can be changed between “km/L” or “L/100km”. When using miles, MPG will be available.

Temperature units can be switched between Celsius and Fahrenheit.

“Brightness”

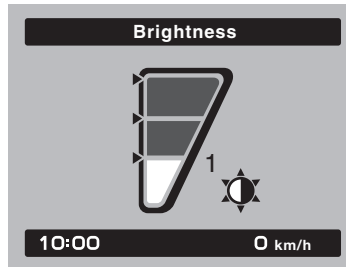

This module allows you to adjust the general brightness level of the display screen.

Select the desired brightness level by rotating the wheel switch, and then press the wheel switch to fix the setting and return to the top MENU screen.

“Clock”



This module allows you to set the clock.

When the clock module is selected, the hours will be highlighted.

Set the hours by rotating the wheel switch. Press the wheel switch inward to confirm and highlight the minutes.

After confirming the minutes, you will be returned to the top MENU screen.

“All Reset”

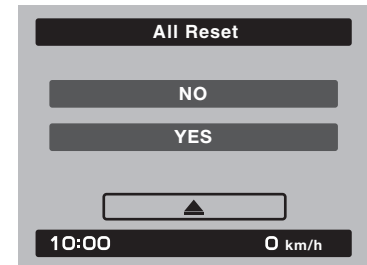

This module resets all settings items (except the odometer and clock) to their default or factory presets.

Select YES to reset all items. After selecting YES, all items will be reset and the screen will automatically return to the top MENU screen.

Clutch lever

EAU12823

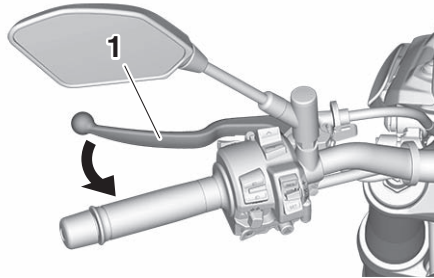

1. Clutch lever

To disengage the drivetrain from the engine, such as when shifting gears, pull the clutch lever toward the handlebar. Release the lever to engage the clutch and transmit power to the rear wheel.

TIP

The lever should be pulled rapidly and released slowly for smooth shifting. (See page 7-3.)

Shift pedal

EAU83692

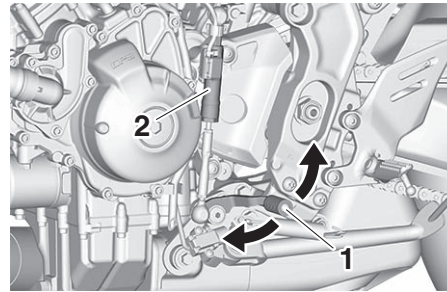

1. Shift pedal
2. Shift rod

The shift pedal is located on the left side of the motorcycle. To shift the transmission to a higher gear, move the shift pedal up. To shift the transmission to a lower gear, move the shift pedal down. (See page 7-3.)

The shift rod is equipped with a shift sensor, which is part of the quick shifter. The shift sensor reads up and down movement, as well as the strength of the input force when the shift pedal is moved.

TIP

To prevent unintended shifts, the quick shifter is programmed to ignore unclear input signals. Therefore, be sure to shift using quick and sufficiently forceful inputs.

Instrument and control functions

EAU26827

Brake lever

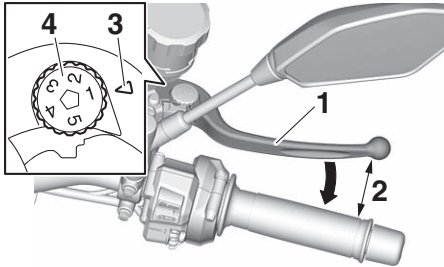

1. Brake lever
2. Distance
3. Match mark
4. Adjusting dial

The brake lever is located on the right side of the handlebar. To apply the front brake, pull the lever toward the throttle grip.

The brake lever is equipped with a brake lever position adjusting dial. To adjust the distance between the brake lever and the throttle grip, push the brake lever away from the throttle grip and rotate the adjusting dial. Make sure the setting number on the adjusting dial aligns with the match mark on the brake lever.

EAU12944

Brake pedal

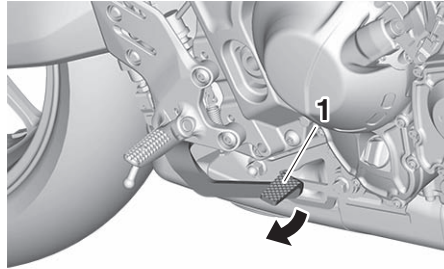

1. Brake pedal

The brake pedal is located on the right side of the motorcycle. To apply the rear brake, press down on the brake pedal.

EAU91461

Brake control system (BC)

The brake control system regulates hydraulic brake pressure for the front and rear wheels independently when the brakes are applied and wheel lock is detected. This system has two settings which can be changed in the settings MENU. (See page 5-15.)

BC1 is standard ABS, which adjusts brake pressure based on vehicle speed and wheel speed data. BC1 is designed to engage and maximize braking when the vehicle is upright. BC2 uses additional data from the IMU to regulate applied brake power when cornering to suppress lateral wheel slip.

Regarding ABS, operate the brakes as you would conventional brakes. When the brake control system engages, a pulsating sensation may be felt at the brake lever or brake pedal as the hydraulic unit rapidly applies and reduces brake pressure. In this situation, continue to apply the brake lever and brake pedal to allow the ABS to work—do not “pump the brakes” as this will reduce braking effectiveness.

WARNING

EWA16051

Always keep a sufficient distance from the vehicle ahead to match the riding speed even with ABS.

- The ABS performs best with long braking distances.
- On certain surfaces, such as rough or gravel roads, the braking distance may be longer with the ABS than without.

The ABS hydraulic unit is monitored by the ABS ECU, which will revert the system to conventional braking if a malfunction occurs.

EWA20891

WARNING

The brake control system is not a substitute for the use of proper riding and braking techniques. The brake control system cannot prevent all loss of traction due to over-braking from excessive speed, or lateral wheel slip when braking on slippery surfaces.

TIP

The ABS performs a self-diagnostic test when the vehicle is started and reaches a speed of 5 km/h (3 mi/h). During this test, a clicking noise may be audible from the hydraulic control unit, and a vibration may be felt at the brake lever or pedal, but this is normal.

ECA20100

NOTICE

Be careful not to damage the wheel sensor or wheel sensor rotor; otherwise, improper performance of the ABS will result.

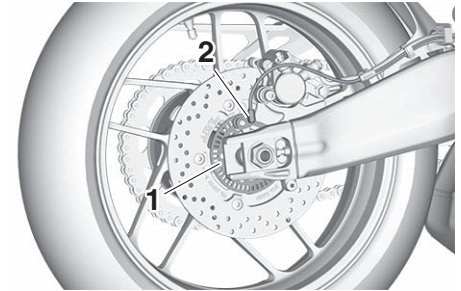

1. Rear wheel sensor rotor
2. Rear wheel sensor

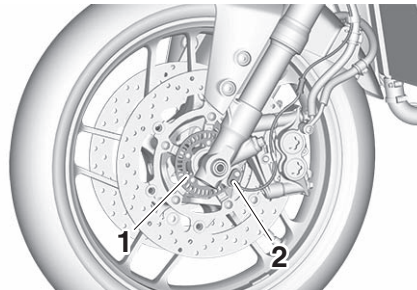

1. Front wheel sensor rotor
2. Front wheel sensor

Instrument and control functions

Fuel tank cap

EAU13077



1. Fuel tank cap lock cover
2. Unlock.

To open the fuel tank cap

Open the fuel tank cap lock cover, insert the key, and then turn it 1/4 turn clockwise. The lock will be released and the fuel tank cap can be opened.

To close the fuel tank cap

With the key still inserted, push down the fuel tank cap. Turn the key 1/4 turn counterclockwise, remove it, and then close the lock cover.

TIP

The fuel tank cap cannot be closed unless the key is in the lock. In addition, the key cannot be removed if the cap is not properly closed and locked.

WARNING

Make sure that the fuel tank cap is properly closed after filling fuel. Leaking fuel is a fire hazard.

EWA11092

Fuel

EAU13222

Make sure there is sufficient gasoline in the tank.

EWA10882

WARNING

Gasoline and gasoline vapors are extremely flammable. To avoid fires and explosions and to reduce the risk of injury when refueling, follow these instructions.

1. Before refueling, turn off the engine and be sure that no one is sitting on the vehicle. Never refuel while smoking, or while in the vicinity of sparks, open flames, or other sources of ignition such as the pilot lights of water heaters and clothes dryers.
2. Do not overfill the fuel tank. When refueling, be sure to insert the pump nozzle into the fuel tank filler hole. Stop filling when the fuel reaches the bottom of the filler tube. Because fuel expands when it heats up, heat from the engine or the sun can cause fuel to spill out of the fuel tank.

Instrument and control functions

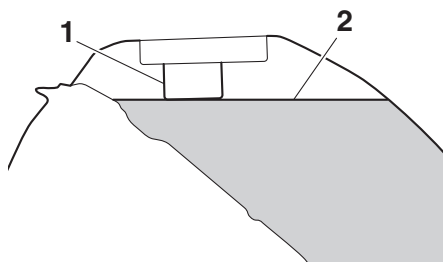

1. Fuel tank filler tube
2. Maximum fuel level

3. Wipe up any spilled fuel immediately. **NOTICE:** Immediately wipe off spilled fuel with a clean, dry, soft cloth, since fuel may deteriorate painted surfaces or plastic parts. [ECA10072]
4. Be sure to securely close the fuel tank cap.

EWA15152

WARNING

Gasoline is poisonous and can cause injury or death. Handle gasoline with care. Never siphon gasoline by mouth. If you should swallow some gasoline or inhale a lot of gasoline vapor, or get some gasoline in your eyes, see your doctor immediately. If

gasoline spills on your skin, wash with soap and water. If gasoline spills on your clothing, change your clothes.

EAU86081

Your Yamaha engine was designed to use unleaded gasoline with a research octane number of 95 or higher. If engine knocking or pinging occurs, use a gasoline of a different brand or higher octane rating.

Recommended fuel:

Unleaded gasoline (E10 acceptable)

Octane number (RON):

95

Fuel tank capacity:

14 L (3.7 US gal, 3.1 Imp.gal)

Fuel tank reserve:

2.8 L (0.74 US gal, 0.62 Imp.gal)

Gasohol

There are two types of gasohol: gasohol containing ethanol and that containing methanol. Gasohol containing ethanol can be used if the ethanol content does not exceed 10% (E10). Gasohol containing methanol is not

recommended by Yamaha because it can cause damage to the fuel system or vehicle performance problems.

ECA11401

NOTICE

Use only unleaded gasoline. The use of leaded gasoline will cause severe damage to internal engine parts, such as the valves and piston rings, as well as to the exhaust system.

Instrument and control functions

EAU86160

Fuel tank overflow hose

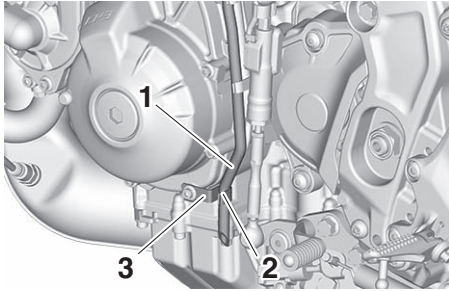

5

1. Fuel tank overflow hose
2. White mark
3. Clamp

The overflow hose drains excess gasoline and directs it safely away from the vehicle.

Before operating the vehicle:

- Check the fuel tank overflow hose connection.
- Check the fuel tank overflow hose for cracks or damage, and replace it if necessary.
- Make sure that the fuel tank overflow hose is not blocked, and clean it if necessary.
- Make sure that the fuel tank overflow hose is positioned as shown.

TIP _____
See page 8-10 for canister information.

EAU13435

Catalytic converter

The exhaust system contains catalytic converter(s) to reduce harmful exhaust emissions.

EWA10863

⚠ WARNING _____

The exhaust system is hot after operation. To prevent a fire hazard or burns:

- Do not park the vehicle near possible fire hazards such as grass or other materials that easily burn.
- Park the vehicle in a place where pedestrians or children are not likely to touch the hot exhaust system.
- Make sure that the exhaust system has cooled down before doing any maintenance work.
- Do not allow the engine to idle more than a few minutes. Long idling can cause a build-up of heat.

EAU57992

Seat

To remove the seat

1. Open the seat lock cover, insert the key into the seat lock, and then turn the key counterclockwise.

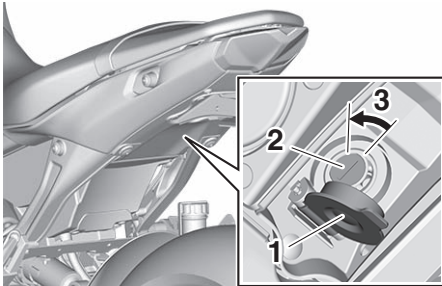

1. Seat lock cover
2. Seat lock
3. Unlock.

2. While holding the key in that position, slide the seat backward and then lift the rear of the seat up, and then pull the seat off.

To install the seat

1. Insert the projections into the seat holders as shown.

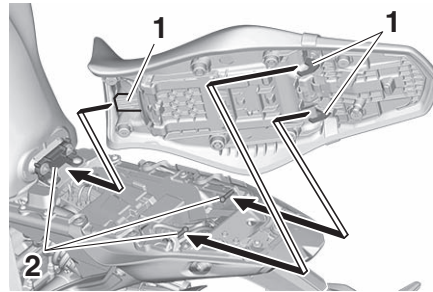

1. Projection
2. Seat holder

2. Push the rear of the seat down to lock it in place.
3. Remove the key.

TIP

Make sure that the seat is properly secured before riding.

EAU91560

Rider footrest position

The rider footrests can be adjusted to one of two positions. From the factory, the footrests are in the low position. Have a Yamaha dealer adjust the positions of the rider footrests.

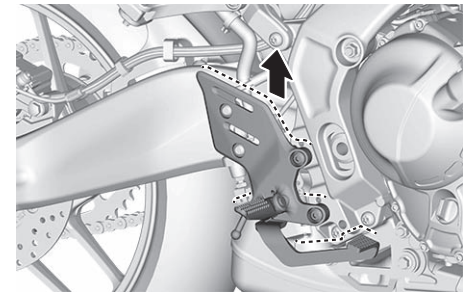
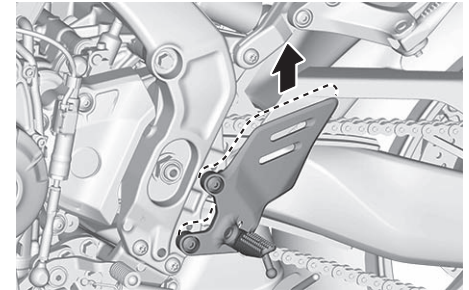

Instrument and control functions

EAU46833

Handlebar position

The handlebar can be adjusted to one of two positions to suit the rider's preference. Have a Yamaha dealer adjust the position of the handlebar.

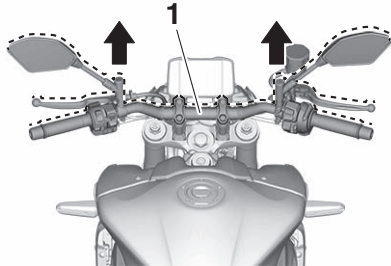

1. Handlebar

5

EAU91640

EWA10181

Adjusting the front fork

WARNING

Always adjust both fork legs equally, otherwise poor handling and loss of stability may result.

This front fork is equipped with spring preload adjusting bolts, rebound damping force adjusting screws, compression damping force adjusting bolts (for fast compression damping) and compression damping force adjusting bolts (for slow compression damping).

ECA22472

NOTICE

- Use extra care to avoid scratching the anodized finish when making suspension adjustments.
- To avoid damaging the suspension's internal mechanisms, do not attempt to turn beyond the maximum or minimum settings.

Spring preload

Turn the adjusting bolt in direction (a) to increase the spring preload.

Turn the adjusting bolt in direction (b) to decrease the spring preload.

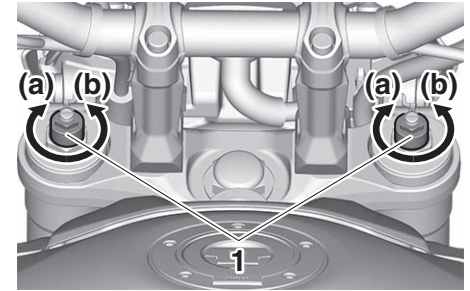

1. Spring preload adjusting bolt

The spring preload setting is determined by measuring distance A, shown in the illustration. The shorter distance A is, the higher the spring preload; the longer distance A is, the lower the spring preload.

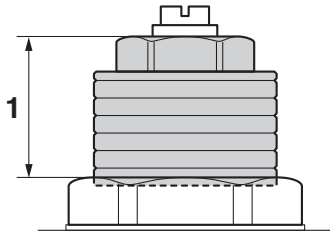

1. Distance A

Spring preload setting:

Minimum (soft):

Distance A = 19.0 mm (0.75 in)

Standard:

Distance A = 15.0 mm (0.59 in)

Maximum (hard):

Distance A = 4.0 mm (0.16 in)

Rebound damping force

Turn the adjusting screw in direction (a) to increase the rebound damping force.

Turn the adjusting screw in direction (b) to decrease the rebound damping force.

To set the rebound damping force, turn the adjuster in direction (a) until it stops, and then count the clicks in direction (b).

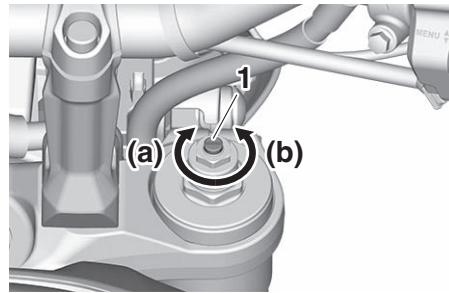

1. Rebound damping force adjusting screw

Rebound damping setting:

Minimum (soft):

26 click(s) in direction (b)

Standard:

15 click(s) in direction (b)

Maximum (hard):

1 click(s) in direction (b)

TIP

- When turning the damping force adjuster in direction (a), the 0 click position and the 1 click position may be the same.

- When turning the damping force adjuster in direction (b), it may click beyond the stated specifications, however such adjustments are ineffective and may damage the suspension.

Compression damping force

To adjust the compression damping force (for fast compression damping)

Turn the adjusting bolt in direction (a) to increase the compression damping force.

Turn the adjusting bolt in direction (b) to decrease the compression damping force.

To set the compression damping force, turn the adjuster in direction (a) until it stops, and then count the turns in direction (b).

Instrument and control functions

5

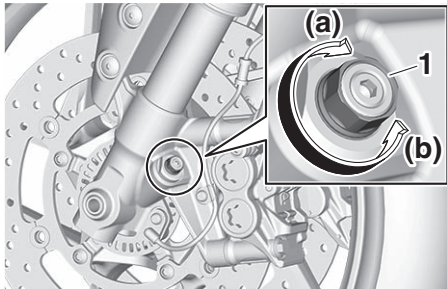

1. Compression damping force adjusting bolt (for fast compression damping)

Compression damping setting (for fast compression damping):

Minimum (soft):

5 1/2 turn(s) in direction (b)

Standard:

3 1/4 turn(s) in direction (b)

Maximum (hard):

0 turn(s) in direction (b)

TIP

When turning the damping force adjuster in direction (b), it may turn beyond the stated specifications, however such adjustments are ineffective and may damage the suspension.

To adjust the compression damping force (for slow compression damping)

Turn the adjusting bolt in direction (a) to increase the compression damping force. Turn the adjusting bolt in direction (b) to decrease the compression damping force. To set the compression damping force, turn the adjuster in direction (a) until it stops, and then count the clicks in direction (b).

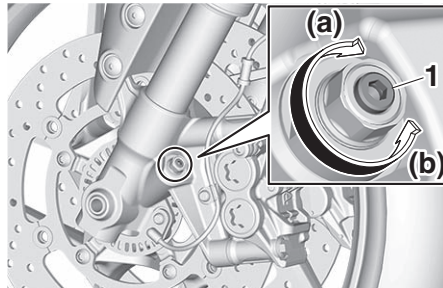

1. Compression damping force adjusting bolt (for slow compression damping)

Compression damping setting (for slow compression damping):

Minimum (soft):

18 click(s) in direction (b)

Standard:

12 click(s) in direction (b)

Maximum (hard):

1 click(s) in direction (b)

TIP

- When turning the damping force adjuster in direction (a), the 0 click position and the 1 click position may be the same.
- When turning the damping force adjuster in direction (b), it may click beyond the stated specifications, however such adjustments are ineffective and may damage the suspension.

Adjusting the shock absorber assembly

EAU83551

This shock absorber assembly is equipped with a spring preload adjusting knob and rebound and compression damping force adjusting knobs.

ECA10102

NOTICE

To avoid damaging the mechanism, do not attempt to turn beyond the maximum or minimum settings.

Spring preload

Turn the adjusting knob in direction (a) to increase the spring preload.

Turn the adjusting knob in direction (b) to decrease the spring preload.

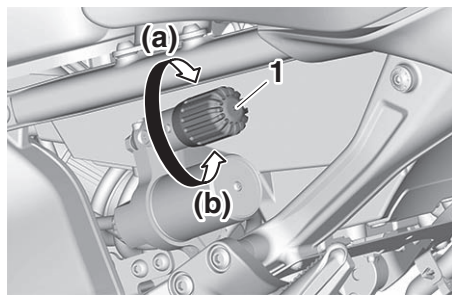

1. Spring preload adjusting knob

The spring preload setting is determined by measuring distance A, shown in the illustration. The shorter the distance A is, the higher the spring preload; the longer distance A is, the lower the spring preload.

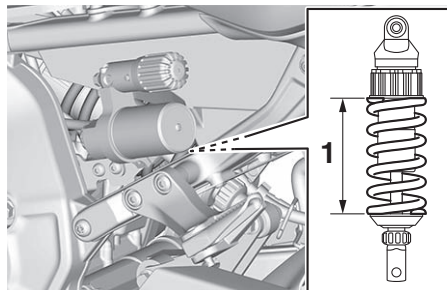

1. Distance A

Spring preload setting:

- Minimum (soft):
Distance A = 154.0 mm (6.06 in)
- Standard:
Distance A = 154.0 mm (6.06 in)
- Maximum (hard):
Distance A = 146.0 mm (5.75 in)

Rebound damping force

Turn the adjusting knob in direction (a) to increase the rebound damping force.

Turn the adjusting knob in direction (b) to decrease the rebound damping force.

To set the rebound damping force, turn the adjuster in direction (a) until it stops, and then count the clicks in direction (b).

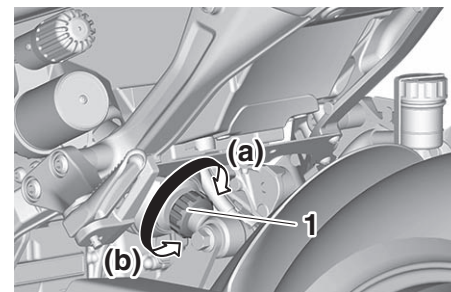

1. Rebound damping force adjusting knob

Rebound damping setting:

- Minimum (soft):
30 click(s) in direction (b)
- Standard:
18 click(s) in direction (b)
- Maximum (hard):
0 click(s) in direction (b)

Instrument and control functions

TIP

- When turning the damping force adjuster in direction (a), the 0 click position and the 1 click position may be the same.
- When turning the damping force adjuster in direction (b), it may click beyond the stated specifications, however such adjustments are ineffective and may damage the suspension.

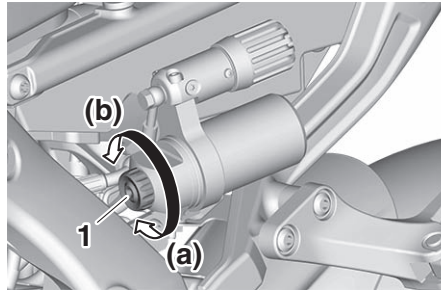

1. Compression damping force adjusting knob

Compression damping setting:

- Minimum (soft):
20 click(s) in direction (b)
- Standard:
10 click(s) in direction (b)
- Maximum (hard):
0 click(s) in direction (b)

TIP

- When turning the damping force adjuster in direction (a), the 0 click position and the 1 click position may be the same.
- When turning the damping force adjuster in direction (b), it may click beyond the stated specifica-

tions, however such adjustments are ineffective and may damage the suspension.

EWA10222

⚠ WARNING

This shock absorber assembly contains highly pressurized nitrogen gas. Read and understand the following information before handling the shock absorber assembly.

- Do not tamper with or attempt to open the cylinder assembly.
- Do not subject the shock absorber assembly to an open flame or other high heat source. This may cause the unit to explode due to excessive gas pressure.
- Do not deform or damage the cylinder in any way. Cylinder damage will result in poor damping performance.
- Do not dispose of a damaged or worn-out shock absorber assembly yourself. Take the shock absorber assembly to a Yamaha dealer for any service.

Compression damping force

Turn the adjusting knob in direction (a) to increase the compression damping force.

Turn the adjusting knob in direction (b) to decrease the compression damping force.

To set the compression damping force, turn the adjuster in direction (a) until it stops, and then count the clicks in direction (b).

Luggage strap holders

EAU84680

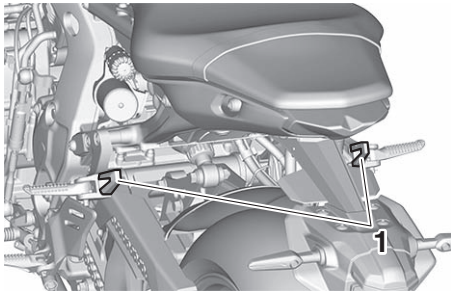

1. Luggage strap holder

Use the indicated strap points to secure luggage ties to the vehicle.

Auxiliary DC connectors

EAU77390

This vehicle is equipped with an auxiliary DC connector and a grip warmer DC connector. Consult your Yamaha dealer before installing any accessories.

Sidestand

EAU15306

The sidestand is located on the left side of the frame. Raise the sidestand or lower it with your foot while holding the vehicle upright.

TIP

The built-in sidestand switch is part of the ignition circuit cut-off system, which cuts the ignition in certain situations. (See the following section for an explanation of the ignition circuit cut-off system.)

5

EWA10242

WARNING

The vehicle must not be ridden with the sidestand down, or if the sidestand cannot be properly moved up (or does not stay up), otherwise the sidestand could contact the ground and distract the operator, resulting in a possible loss of control. Yamaha's ignition circuit cut-off system has been designed to assist the operator in fulfilling the responsibility of raising the sidestand before starting off. Therefore, check

Instrument and control functions

this system regularly and have a Yamaha dealer repair it if it does not function properly.

EAU57952

Ignition circuit cut-off system

This system prevents in-gear engine starts unless the clutch lever is pulled and the sidestand is up. Also, it will stop the running engine should the sidestand be lowered while the transmission is in gear.

Periodically check this system via the following procedure.

TIP

- This check is most reliable if performed with a warmed-up engine.
 - See pages 5-2 and 5-3 for switch operation information.
-

Instrument and control functions

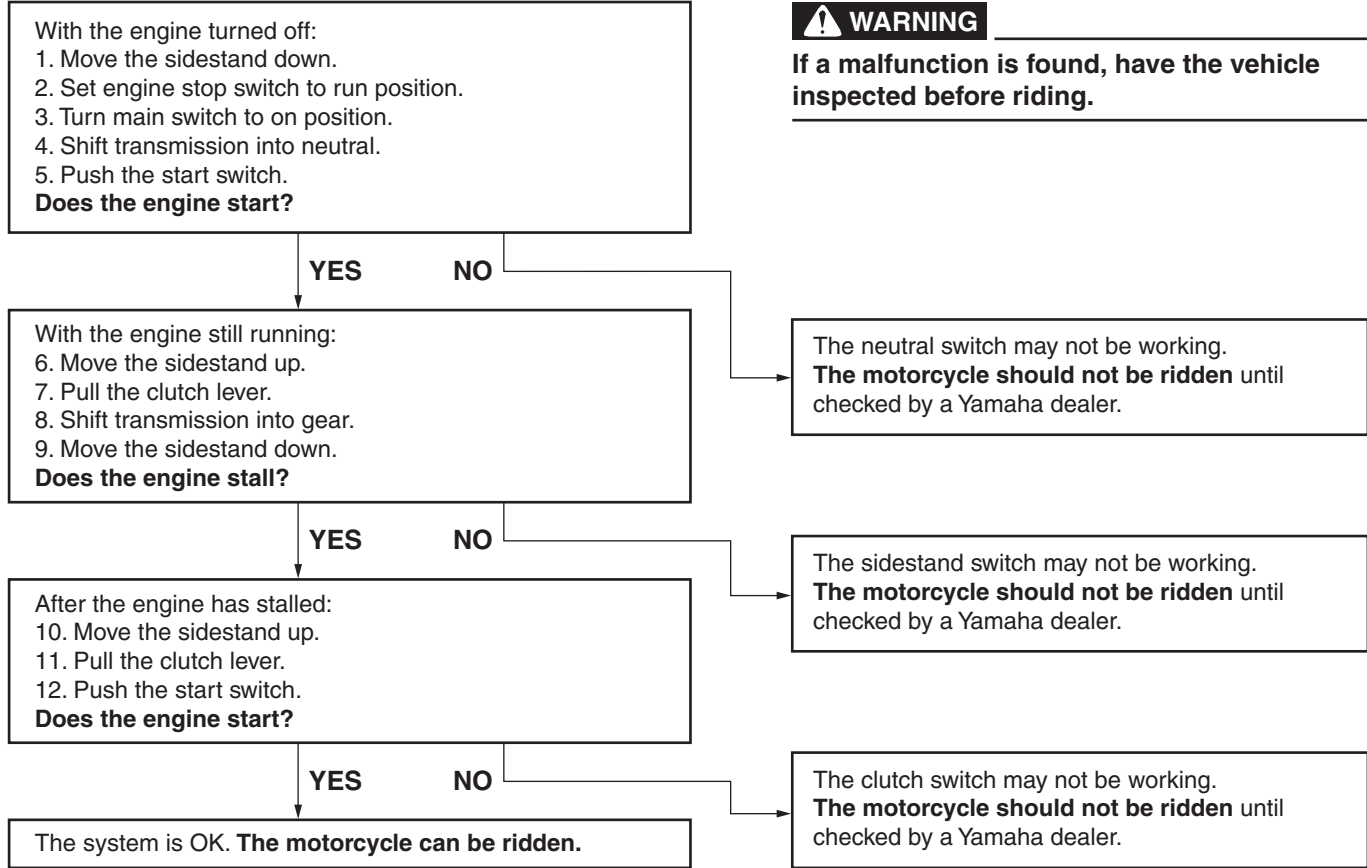

For your safety – pre-operation checks

EAU1559B

Inspect your vehicle each time you use it to make sure the vehicle is in safe operating condition. Always follow the inspection and maintenance procedures and schedules described in the Owner's Manual.

EWA11152

WARNING

Failure to inspect or maintain the vehicle properly increases the possibility of an accident or equipment damage. Do not operate the vehicle if you find any problem. If a problem cannot be corrected by the procedures provided in this manual, have the vehicle inspected by a Yamaha dealer.

Before using this vehicle, check the following points:

ITEM	CHECKS	PAGE
Fuel	<ul style="list-style-type: none">• Check fuel level in fuel tank.• Refuel if necessary.• Check fuel line for leakage.• Check fuel tank overflow hose for obstructions, cracks or damage, and check hose connection.	5-21, 5-23
Engine oil	<ul style="list-style-type: none">• Check oil level in engine.• If necessary, add recommended oil to specified level.• Check vehicle for oil leakage.	8-10
Coolant	<ul style="list-style-type: none">• Check coolant level in reservoir.• If necessary, add recommended coolant to specified level.• Check cooling system for leakage.	8-13
Front brake	<ul style="list-style-type: none">• Check operation.• If soft or spongy, have Yamaha dealer bleed hydraulic system.• Check brake pads for wear.• Replace if necessary.• Check fluid level in reservoir.• If necessary, add specified brake fluid to specified level.• Check hydraulic system for leakage.	8-19, 8-20

6

For your safety – pre-operation checks

ITEM	CHECKS	PAGE
Rear brake	<ul style="list-style-type: none"> • Check operation. • If soft or spongy, have Yamaha dealer bleed hydraulic system. • Check brake pads for wear. • Replace if necessary. • Check fluid level in reservoir. • If necessary, add specified brake fluid to specified level. • Check hydraulic system for leakage. 	8-19, 8-20
Clutch	<ul style="list-style-type: none"> • Check operation. • Lubricate cable if necessary. • Check lever free play. • Adjust if necessary. 	8-18
Throttle grip	<ul style="list-style-type: none"> • Check for smooth rotation and automatic return. 	8-25
Control cables	<ul style="list-style-type: none"> • Make sure that operation is smooth. • Lubricate if necessary. 	8-24
Drive chain	<ul style="list-style-type: none"> • Check chain slack. • Adjust if necessary. • Check chain condition. • Lubricate if necessary. 	8-22, 8-24
Wheels and tires	<ul style="list-style-type: none"> • Check for damage. • Check tire condition and tread depth. • Check air pressure. • Correct if necessary. 	8-15, 8-17
Brake and shift pedals	<ul style="list-style-type: none"> • Make sure that operation is smooth. • Lubricate pedal pivoting points if necessary. 	8-25
Brake and clutch levers	<ul style="list-style-type: none"> • Make sure that operation is smooth. • Lubricate lever pivoting points if necessary. 	8-26
Sidestand	<ul style="list-style-type: none"> • Make sure that operation is smooth. • Lubricate pivot if necessary. 	8-26
Chassis fasteners	<ul style="list-style-type: none"> • Make sure that all nuts, bolts and screws are properly tightened. • Tighten if necessary. 	—

For your safety – pre-operation checks

ITEM	CHECKS	PAGE
Instruments, lights, signals and switches	<ul style="list-style-type: none">• Check operation.• Correct if necessary.	–
Sidestand switch	<ul style="list-style-type: none">• Check operation of ignition circuit cut-off system.• If system is not working correctly, have Yamaha dealer check vehicle.	5-30

EAU15952

Read the Owner's Manual carefully to become familiar with all controls. If there is a control or function you do not understand, ask your Yamaha dealer.

EWA10272



Failure to familiarize yourself with the controls can lead to loss of control, which could cause an accident or injury.

EAU16842

Engine break-in

There is never a more important period in the life of your engine than the period between 0 and 1600 km (1000 mi). For this reason, you should read the following material carefully.

Since the engine is brand new, do not put an excessive load on it for the first 1600 km (1000 mi). The various parts in the engine wear and polish themselves to the correct operating clearances. During this period, prolonged full-throttle operation or any condition that might result in engine overheating must be avoided.

EAU17094

0–1000 km (0–600 mi)

Avoid prolonged operation above 5300 r/min. **NOTICE: After 1000 km (600 mi) of operation, the engine oil must be changed and the oil filter cartridge or element replaced.** [ECA10303]

1000–1600 km (600–1000 mi)

Avoid prolonged operation above 6300 r/min.

1600 km (1000 mi) and beyond

The vehicle can now be operated normally.

ECA10311

NOTICE

- **Keep the engine speed out of the tachometer red zone.**
- **If any engine trouble should occur during the engine break-in period, immediately have a Yamaha dealer check the vehicle.**

Operation and important riding points

Starting the engine

EAU91811

The ignition circuit cut-off system will enable starting when:

- the transmission is in the neutral position or
- the transmission is in gear, the sidestand is up, and the clutch lever is pulled.

To start the engine

1. Turn the main switch on and set the engine stop switch to the run position.
2. Confirm the indicator and warning light(s) come on for a few seconds, and then go off. (See page 5-5.)

TIP

- Do not start the engine if the engine trouble warning light remains on.
- The oil pressure and coolant temperature warning light should come on and stay on until the engine is started.

- The ABS warning light should come on and stay on until the vehicle reaches a speed of 5 km/h (3 mi/h).

ECA24110

NOTICE

If a warning or indicator light does not work as described above, have a Yamaha dealer check the vehicle.

3. Shift the transmission into the neutral position.
4. Start the engine by pushing the start switch.
5. Release the start switch when the engine starts, or after 5 seconds. Wait 10 seconds before pressing the switch again to allow battery voltage to restore.

TIP

If the engine fails to start, try again with the throttle grip turned by a 1/4 turn (20 degrees) open.

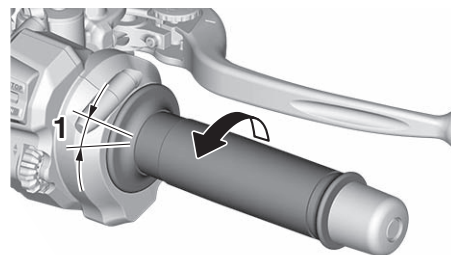

1. 1/4 turn (20 degrees)

ECA11043

NOTICE

For maximum engine life, never accelerate hard when the engine is cold!

EAU68221

EAUN0073

EAU91542

TIP

This model is equipped with:

- an inertial measurement unit (IMU). This unit stops the engine in case of a turnover. Turn the main switch off and then on before attempting to restart the engine. Failing to do so will prevent the engine from starting even though the engine will crank when pushing the start switch.
- an engine auto-stop system. The engine stops automatically if left idling for 20 minutes. If the engine stops, simply push the start switch to restart the engine.

NOTICE

Do not ride through deep water, otherwise the engine may be damaged. Avoid puddles because they may be deeper than expected.

ECAN0072

Shifting

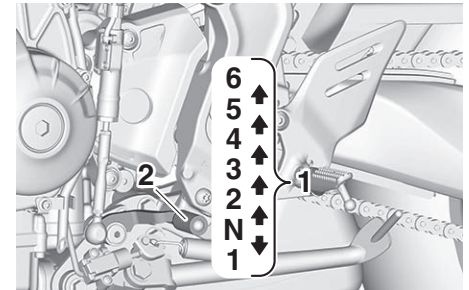

1. Gear positions
2. Shift pedal

Shifting gears lets you control the amount of engine power available for starting off, accelerating, climbing hills, etc. The gear positions are shown in the illustration.

TIP

- To shift the transmission into the neutral position (**N**), press the shift pedal down repeatedly until it reaches the end of its travel, and then slightly raise it.
- This model is equipped with a quick shifter. (See page 4-6.)

Operation and important riding points

NOTICE

ECA22523

- When shifting, press the shift pedal firmly until you feel the gear shift is complete.
- Even with the transmission in the neutral position, do not coast for long periods of time with the engine off, nor tow the motorcycle for long distances. The transmission is properly lubricated only when the engine is running. Inadequate lubrication may damage the transmission.
- Except when using the quick shifter, always pull the clutch lever when changing gears to avoid damaging the engine, transmission, and drivetrain.

To start out and accelerate

EAU85370

1. Pull the clutch lever to disengage the clutch.
2. Shift the transmission into first gear. The neutral indicator light should go out.

3. Open the throttle gradually, and at the same time, release the clutch lever slowly.
4. After starting out, close the throttle, and at the same time, quickly pull the clutch lever in.
5. Shift the transmission into second gear. (Make sure not to shift the transmission into the neutral position.)
6. Open the throttle part way and gradually release the clutch lever.
7. Follow the same procedure when shifting to the next higher gear.

To decelerate

EAU85380

1. Release the throttle and apply both the front and the rear brakes smoothly to slow the motorcycle.
2. As the vehicle decelerates, shift to a lower gear.
3. When the engine is about to stall or runs roughly, pull the clutch lever in, use the brakes to slow the motorcycle, and continue to downshift as necessary.

4. Once the motorcycle has stopped, the transmission can be shifted into the neutral position. The neutral indicator light should come on and then the clutch lever can be released.

EWA17380

! WARNING

- Improper braking can cause loss of control or traction. Always use both brakes and apply them smoothly.
- Make sure that the motorcycle and the engine have sufficiently slowed before shifting to a lower gear. Engaging a lower gear when the vehicle or engine speed is too high could make the rear wheel lose traction or the engine to over-rev. This could cause loss of control, an accident and injury. It could also cause engine or drive train damage.

Tips for reducing fuel consumption

EAU16811

Fuel consumption depends largely on your riding style. Consider the following tips to reduce fuel consumption:

- Shift up swiftly, and avoid high engine speeds during acceleration.
- Do not rev the engine while shifting down, and avoid high engine speeds with no load on the engine.
- Turn the engine off instead of letting it idle for an extended length of time (e.g., in traffic jams, at traffic lights or at railroad crossings).

Parking

EAU17214

When parking, stop the engine, and then remove the key from the main switch.

EWA10312

WARNING

- **Since the engine and exhaust system can become very hot, park in a place where pedestrians or children are not likely to touch them and be burned.**
 - **Do not park on a slope or on soft ground, otherwise the vehicle may overturn, increasing the risk of a fuel leak and fire.**
 - **Do not park near grass or other flammable materials which might catch fire.**
-

Periodic maintenance and adjustment

EAU17246

EWA15123

EAU17303

Periodic inspection, adjustment, and lubrication will keep your vehicle in the safest and most efficient condition possible. Safety is an obligation of the vehicle owner/operator. The most important points of vehicle inspection, adjustment, and lubrication are explained on the following pages.

The intervals given in the periodic maintenance charts should be simply considered as a general guide under normal riding conditions. However, depending on the weather, terrain, geographical location, and individual use, the maintenance intervals may need to be shortened.

WARNING

EWA10322

Failure to properly maintain the vehicle or performing maintenance activities incorrectly may increase your risk of injury or death during service or while using the vehicle. If you are not familiar with vehicle service, have a Yamaha dealer perform service.

WARNING

Turn off the engine when performing maintenance unless otherwise specified.

- **A running engine has moving parts that can catch on body parts or clothing and electrical parts that can cause shocks or fires.**
 - **Running the engine while servicing can lead to eye injury, burns, fire, or carbon monoxide poisoning – possibly leading to death. See page 2-3 for more information about carbon monoxide.**
-

WARNING

EWA15461

Brake discs, calipers, drums, and linings can become very hot during use. To avoid possible burns, let brake components cool before touching them.

Emission controls not only function to ensure cleaner air, but are also vital to proper engine operation and maximum performance. In the following periodic maintenance charts, the services related to emissions control are grouped separately. These services require specialized data, knowledge, and equipment. Maintenance, replacement, or repair of the emission control devices and systems may be performed by any repair establishment or individual that is certified (if applicable). Yamaha dealers are trained and equipped to perform these particular services.

Tool kit

EAU85230

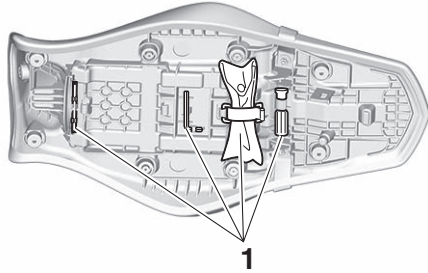

1. Tool kit

The tool kit is in the location shown. The information included in this manual and the tools provided in the tool kit are intended to assist you in the performance of preventive maintenance and minor repairs. However, a torque wrench and other tools are necessary to perform certain maintenance work correctly.

TIP _____

If you do not have the tools or experience required for a particular job, have your Yamaha dealer perform it for you.

Periodic maintenance and adjustment

EAU91891

TIP

- The annual checks must be performed every year, except if a kilometer-based maintenance is performed instead.
- For 31000 km or 30 months, repeat the maintenance intervals starting from 7000 km or 6 months.
- Items marked with an asterisk require special tools, data and technical skills, have a Yamaha dealer perform the service.

EAU91902

Periodic maintenance chart for the emission control system

No.	ITEM	ROUTINE	INITIAL	ODOMETER READINGS					ANNUAL CHECK
			1000 km or 1 month	7000 km or 6 months	13000 km or 12 months	19000 km or 18 months	25000 km or 24 months		
1	* Fuel line	<ul style="list-style-type: none"> • Check fuel hoses for cracks or damage. • Replace if necessary. 		√	√	√	√	√	
2	* Spark plugs	<ul style="list-style-type: none"> • Check condition. • Adjust gap and clean. 		√					
		<ul style="list-style-type: none"> • Replace. 	Every 19000 km (12000 mi) or 18 months						
3	* Valve clearance	<ul style="list-style-type: none"> • Check and adjust valve clearance when engine is cold. 	Every 42000 km (26600 mi)						
4	* Fuel injection	<ul style="list-style-type: none"> • Adjust synchronization. 	√	√	√	√	√	√	
5	* Exhaust system	<ul style="list-style-type: none"> • Check for leakage. • Tighten if necessary. • Replace gasket(s) if necessary. 		√	√	√	√		

Periodic maintenance and adjustment

No.	ITEM	ROUTINE	INITIAL	ODOMETER READINGS					ANNUAL CHECK
			1000 km or 1 month	7000 km or 6 months	13000 km or 12 months	19000 km or 18 months	25000 km or 24 months		
6	*	Evaporative emission control system	<ul style="list-style-type: none"> • Check control system for damage. • Replace if necessary. 			√		√	

Periodic maintenance and adjustment

EAU92131

General maintenance and lubrication chart

No.	ITEM	ROUTINE	INITIAL	ODOMETER READINGS					ANNUAL CHECK
			1000 km or 1 month	7000 km or 6 months	13000 km or 12 months	19000 km or 18 months	25000 km or 24 months		
1	* Diagnostic system check	<ul style="list-style-type: none"> Perform dynamic inspection using Yamaha diagnostic tool. Check the error codes. 	√	√	√	√	√	√	
2	* Air filter element	<ul style="list-style-type: none"> Replace. 	Every 40000 km (24000 mi)						
3	Clutch	<ul style="list-style-type: none"> Check operation. Adjust. 	√	√	√	√	√		
4	* Front brake	<ul style="list-style-type: none"> Check operation, fluid level, and for fluid leakage. Replace brake pads if necessary. 	√	√	√	√	√	√	
5	* Rear brake	<ul style="list-style-type: none"> Check operation, fluid level, and for fluid leakage. Replace brake pads if necessary. 	√	√	√	√	√	√	
6	* Brake hoses	<ul style="list-style-type: none"> Check for cracks or damage. Check for correct routing and clamping. 		√	√	√	√	√	
		<ul style="list-style-type: none"> Replace. 	Every 4 years						
7	* Brake fluid	<ul style="list-style-type: none"> Change. 	Every 2 years						
8	* Wheels	<ul style="list-style-type: none"> Check runout and for damage. Replace if necessary. 		√	√	√	√		
9	* Tires	<ul style="list-style-type: none"> Check tread depth and for damage. Replace if necessary. Check air pressure. Correct if necessary. 		√	√	√	√	√	

Periodic maintenance and adjustment

No.	ITEM	ROUTINE	INITIAL	ODOMETER READINGS					ANNUAL CHECK
			1000 km or 1 month	7000 km or 6 months	13000 km or 12 months	19000 km or 18 months	25000 km or 24 months		
10	* Wheel bearings	<ul style="list-style-type: none"> Check bearings for looseness or damage. 		√	√	√	√		
11	* Swingarm	<ul style="list-style-type: none"> Check operation and for excessive play. 		√	√	√	√		
		<ul style="list-style-type: none"> Lubricate with lithium-soap-based grease. 	Every 50000 km (30000 mi)						
12	Drive chain	<ul style="list-style-type: none"> Check chain slack, alignment and condition. Adjust and lubricate chain with a special O-ring chain lubricant thoroughly. 	Every 1000 km (600 mi) and after washing the motorcycle, riding in the rain or riding in wet areas						
13	* Steering bearings	<ul style="list-style-type: none"> Check bearing assemblies for looseness. 	√	√	√	√	√		
		<ul style="list-style-type: none"> Moderately repack with lithium-soap-based grease. 	Every 19000 km (12000 mi)						
14	* Chassis fasteners	<ul style="list-style-type: none"> Make sure that all nuts, bolts and screws are properly tightened. 		√	√	√	√	√	
15	Brake lever pivot shaft	<ul style="list-style-type: none"> Lubricate with silicone grease. 		√	√	√	√	√	
16	Brake pedal pivot shaft	<ul style="list-style-type: none"> Lubricate with lithium-soap-based grease. 		√	√	√	√	√	
17	Clutch lever pivot shaft	<ul style="list-style-type: none"> Lubricate with lithium-soap-based grease. 		√	√	√	√	√	
18	Shift pedal pivot shaft	<ul style="list-style-type: none"> Lubricate with lithium-soap-based grease. 		√	√	√	√	√	

Periodic maintenance and adjustment

No.	ITEM	ROUTINE	INITIAL	ODOMETER READINGS					ANNUAL CHECK
			1000 km or 1 month	7000 km or 6 months	13000 km or 12 months	19000 km or 18 months	25000 km or 24 months		
19	Sidestand	<ul style="list-style-type: none"> • Check operation. • Lubricate with molybdenum disulfide grease. 		√	√	√	√	√	
20 *	Sidestand switch	<ul style="list-style-type: none"> • Check operation and replace if necessary. 	√	√	√	√	√	√	
21 *	Front fork	<ul style="list-style-type: none"> • Check operation and for oil leakage. • Replace if necessary. 		√	√	√	√		
22 *	Shock absorber assembly	<ul style="list-style-type: none"> • Check operation and for oil leakage. • Replace if necessary. 		√	√	√	√		
23 *	Rear suspension relay arm and connecting arm pivoting points	<ul style="list-style-type: none"> • Check operation. 		√	√	√	√		
24	Engine oil	<ul style="list-style-type: none"> • Change. • Check oil level and vehicle for oil leakage. 	√	√	√	√	√	√	
25	Engine oil filter cartridge	<ul style="list-style-type: none"> • Replace. 	√		√		√		
26 *	Cooling system	<ul style="list-style-type: none"> • Check coolant level and vehicle for coolant leakage. 		√	√	√	√	√	
		<ul style="list-style-type: none"> • Change with Yamaha genuine coolant. 	Every 3 years						
27 *	Front and rear brake switches	<ul style="list-style-type: none"> • Check operation. 	√	√	√	√	√	√	

Periodic maintenance and adjustment

No.	ITEM	ROUTINE	INITIAL	ODOMETER READINGS					ANNUAL CHECK
			1000 km or 1 month	7000 km or 6 months	13000 km or 12 months	19000 km or 18 months	25000 km or 24 months		
28	Control cables	<ul style="list-style-type: none"> Apply Yamaha cable lubricant or other suitable cable lubricant thoroughly. 		√	√	√	√	√	√
29	* Throttle grip	<ul style="list-style-type: none"> Check operation. Lubricate throttle grip housing tube guides. 		√	√	√	√	√	√
30	* Lights, signals and switches	<ul style="list-style-type: none"> Check operation. Adjust headlight beam. 	√	√	√	√	√	√	√

EAU18681

TIP

- Air filter
 - This model's air filter is equipped with a disposable oil-coated paper element, which must not be cleaned with compressed air to avoid damaging it.
 - The air filter element needs to be replaced more frequently when riding in unusually wet or dusty areas.
- Hydraulic brake service
 - Regularly check and, if necessary, correct the brake fluid level.
 - Every two years replace the internal components of the brake master cylinders and calipers, and change the brake fluid.
 - Replace the brake hoses every four years and if cracked or damaged.

Periodic maintenance and adjustment

EAU19653

Checking the spark plugs

The spark plugs are important engine components, which should be checked periodically, preferably by a Yamaha dealer. Since heat and deposits will cause any spark plug to slowly erode, they should be removed and checked in accordance with the periodic maintenance and lubrication chart. In addition, the condition of the spark plugs can reveal the condition of the engine.

The porcelain insulator around the center electrode of each spark plug should be a medium-to-light tan (the ideal color when the vehicle is ridden normally), and all spark plugs installed in the engine should have the same color. If any spark plug shows a distinctly different color, the engine could be operating improperly. Do not attempt to diagnose such problems yourself. Instead, have a Yamaha dealer check the vehicle.

If a spark plug shows signs of electrode erosion and excessive carbon or other deposits, it should be replaced.

Specified spark plug:
NGK/LMAR9A-9

Before installing a spark plug, the spark plug gap should be measured with a wire thickness gauge and, if necessary, adjusted to specification.

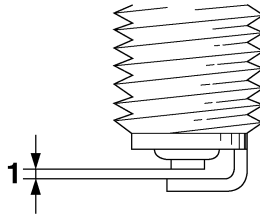

1. Spark plug gap

Spark plug gap:
0.8–0.9 mm (0.031–0.035 in)

Clean the surface of the spark plug gasket and its mating surface, and then wipe off any grime from the spark plug threads.

Tightening torque:
Spark plug:
13 N·m (1.3 kgf·m, 9.6 lb·ft)

TIP

If a torque wrench is not available when installing a spark plug, a good estimate of the correct torque is 1/4–1/2 turn past finger tight. However, the spark plug should be tightened to the specified torque as soon as possible.

ECA10841

NOTICE

Do not use any tools to remove or install the spark plug cap, otherwise the ignition coil coupler may get damaged. The spark plug cap may be difficult to remove because the rubber seal on the end of the cap fits tightly. To remove the spark plug cap, simply twist it back and forth while pulling it out; to install it, twist it back and forth while pushing it in.

Canister

EAU36113

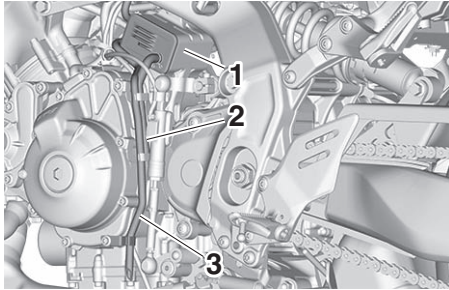

1. Canister
2. Canister breather
3. Fuel tank overflow hose

This model is equipped with a canister to prevent the discharging of fuel vapor into the atmosphere. Before operating this vehicle, make sure to check the following:

- Check each hose connection.
- Check each hose and canister for cracks or damage. Replace if damaged.
- Make sure that the canister breather is not blocked, and if necessary, clean it.

Engine oil

EAU1990G

The engine oil level should be checked regularly. In addition, the oil must be changed and the oil filter cartridge replaced at the intervals specified in the periodic maintenance chart.

Recommended engine oil:

See page 10-1.

Oil quantity:

Oil change:

2.80 L (2.96 US qt, 2.46 Imp.qt)

With oil filter removal:

3.20 L (3.38 US qt, 2.82 Imp.qt)

ECA11621

NOTICE

- **In order to prevent clutch slippage (since the engine oil also lubricates the clutch), do not mix any chemical additives. Do not use oils with a diesel specification of “CD” or oils of a higher quality than specified. In addition, do not use oils labeled “ENERGY CONSERVING II” or higher.**
- **Make sure that no foreign material enters the crankcase.**

To check the engine oil level

1. After warming up the engine, wait a few minutes for the oil level to settle for an accurate reading.
2. With the vehicle on a level surface, hold it upright for an accurate reading.
3. Look at the check window located at the bottom-right side of the crankcase.

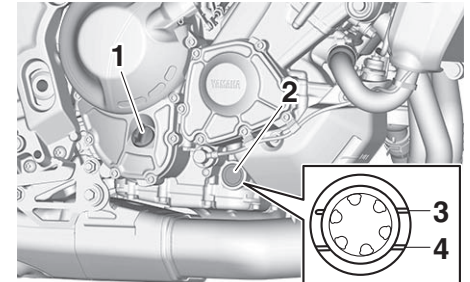

1. Engine oil filler cap
2. Engine oil level check window
3. Maximum level mark
4. Minimum level mark

TIP

The engine oil should be between the minimum and maximum level marks.

Periodic maintenance and adjustment

- If the engine oil is at or below the minimum level mark, remove the oil filler cap and add oil.
- Check the engine oil filler cap O-ring. Replace if damaged.

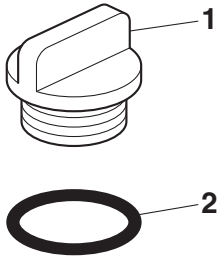

- Engine oil filler cap
- O-ring

- Install the engine oil filler cap.

To change the engine oil (and filter)

- Start the engine and allow it to idle for a few minutes to warm up the oil, and then stop the engine.
- Place an oil pan under the engine to collect the used oil.
- Remove the engine oil filler cap, and then the engine oil drain bolt and gasket.

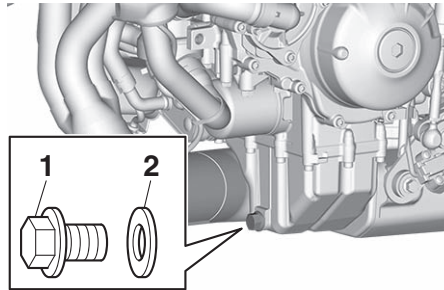

- Engine oil drain bolt
- Gasket

TIP

Skip steps 4–6 if the oil filter cartridge is not being replaced.

- Remove the oil filter cartridge with an oil filter wrench.

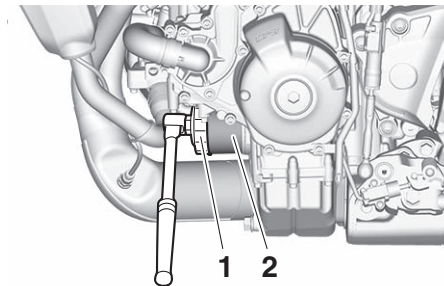

- Oil filter wrench
- Oil filter cartridge

TIP

An oil filter wrench is available at a Yamaha dealer.

- Apply a thin coat of clean engine oil to the O-ring of the new oil filter cartridge.

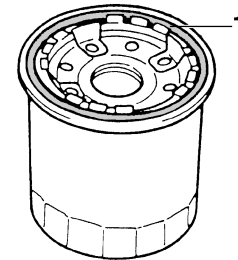

- O-ring

TIP

Make sure that the O-ring is properly seated.

- Install the new oil filter cartridge, and then tighten to the specified torque.

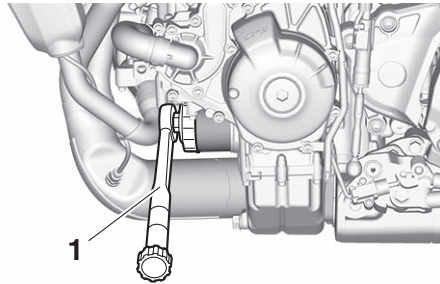

1. Torque wrench

Tightening torque:

Oil filter cartridge:
17 N·m (1.7 kgf·m, 13 lb·ft)

7. Install the engine oil drain bolt with a new gasket, and then tighten the bolt to the specified torque.

Tightening torque:

Engine oil drain bolt:
43 N·m (4.3 kgf·m, 32 lb·ft)

8. Pour the specified amount of the recommended oil into the crankcase.

TIP _____

Using a funnel is recommended.

9. After checking the engine oil filler cap O-ring, install the filler cap.

TIP _____

Wipe off any spilled oil before starting the engine.

10. Start the engine and let it idle while checking for oil leaks.

TIP _____

If any oil leaks are found which you cannot fix, have the vehicle inspected.

11. Stop the engine, wait a few minutes for the oil level to settle, and then check the oil level one last time. **NOTICE: Do not operate the vehicle until you know that the engine oil level is sufficient.**

[ECA10012]

Why Yamalube

YAMALUBE oil is a Genuine YAMAHA Part born of the engineers' passion and belief that engine oil is an important liquid engine component. We form teams of specialists in the fields of mechanical engineering, chemistry, electronics and track testing, and have them develop the engine together with the oil it will use. Yamalube oils take full advantage of the base oil's qualities and blend in the ideal balance of additives to make sure the final oil clears our performance standards. Thus, Yamalube mineral, semisynthetic and synthetic oils have their own distinct characters and value. Yamaha's experience gained over many years of research and development into oil since the 1960's helps make Yamalube the best choice for your Yamaha engine.

YAMALUBE®

Periodic maintenance and adjustment

Coolant

EAU51203

The coolant level should be checked regularly. In addition, the coolant must be changed at the intervals specified in the periodic maintenance chart.

Recommended coolant:

YAMALUBE coolant

Coolant quantity:

Coolant reservoir (max level mark):
0.28 L (0.30 US qt, 0.25 Imp.qt)

Radiator (including all routes):
1.72 L (1.82 US qt, 1.51 Imp.qt)

TIP

If genuine Yamaha coolant is not available, use an ethylene glycol antifreeze containing corrosion inhibitors for aluminum engines and mix with distilled water at a 1:1 ratio.

EAU20097

To check the coolant level

Since the coolant level varies with engine temperature, check when the engine is cold.

1. Park the vehicle on a level surface.

2. With the vehicle in an upright position, look at the coolant level in the reservoir.

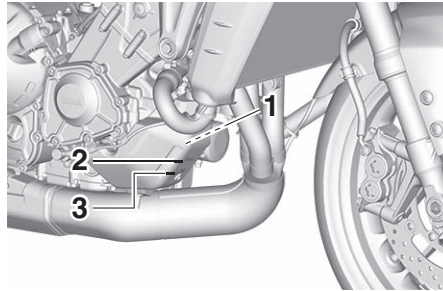

1. Coolant reservoir
2. Maximum level mark
3. Minimum level mark

3. If the coolant is at or below the minimum level mark, remove the coolant reservoir cap. **WARNING! Remove only the coolant reservoir cap. Never attempt to remove the radiator cap when the engine is hot.** [EWA15162]

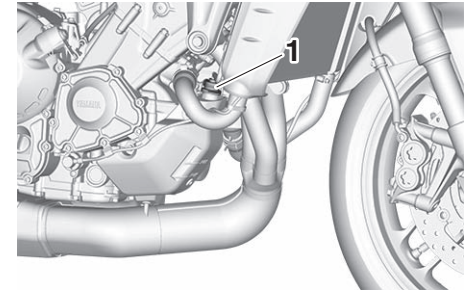

1. Coolant reservoir cap

4. Add coolant to the maximum level mark. **NOTICE: If coolant is not available, use distilled water or soft tap water instead. Do not use hard water or salt water since it is harmful to the engine. If water has been used instead of coolant, replace it with coolant as soon as possible, otherwise the cooling system will not be protected against frost and corrosion. If water has been added to the coolant, have a Yamaha dealer check the anti-freeze content of the coolant as soon as possible, otherwise the effectiveness of the coolant will be reduced.** [ECA10473]

Periodic maintenance and adjustment

5. Install the coolant reservoir cap.

Changing the coolant

EAU33032

The coolant must be changed at the intervals specified in the periodic maintenance and lubrication chart. Have a Yamaha dealer change the coolant.

WARNING! Never attempt to remove the radiator cap when the engine is hot. [EWA10382]

Air filter element

EAU36765

The air filter element must be replaced at the intervals specified in the periodic maintenance and lubrication chart. Have a Yamaha dealer replace the air filter element.

Checking the engine idling speed

EAU44735

Check the engine idling speed and, if necessary, have it corrected by a Yamaha dealer.

Engine idling speed:
1200–1400 r/min

Periodic maintenance and adjustment

EAU21403

Valve clearance

The valves are an important engine component, and since valve clearance changes with use, they must be checked and adjusted at the intervals specified in the periodic maintenance chart. Unadjusted valves can result in improper air-fuel mixture, engine noise, and eventually engine damage. To prevent this from occurring, have your Yamaha dealer check and adjust the valve clearance at regular intervals.

TIP

This service must be performed when the engine is cold.

8

EAU69793

Tires

Tires are the only contact between the vehicle and the road. Safety in all conditions of riding depends on a relatively small area of road contact. Therefore, it is essential to maintain the tires in good condition at all times and replace them at the appropriate time with the specified tires.

Tire air pressure

The tire air pressure should be checked and, if necessary, adjusted before each ride.

EWA10504



WARNING

Operation of this vehicle with improper tire pressure may cause severe injury or death from loss of control.

- The tire air pressure must be checked and adjusted on cold tires (i.e., when the temperature of the tires equals the ambient temperature).
- The tire air pressure must be adjusted in accordance with the riding speed and with the total

weight of rider, passenger, cargo, and accessories approved for this model.

Cold tire air pressure:

1 person:

Front:

250 kPa (2.50 kgf/cm², 36 psi)

Rear:

290 kPa (2.90 kgf/cm², 42 psi)

2 persons:

Front:

250 kPa (2.50 kgf/cm², 36 psi)

Rear:

290 kPa (2.90 kgf/cm², 42 psi)

Maximum load:

Vehicle:

166 kg (366 lb)

The vehicle's maximum load is the combined weight of the rider, passenger, cargo, and any accessories.

EWA10512



WARNING

Never overload your vehicle. Operation of an overloaded vehicle could cause an accident.

Periodic maintenance and adjustment

Tire inspection

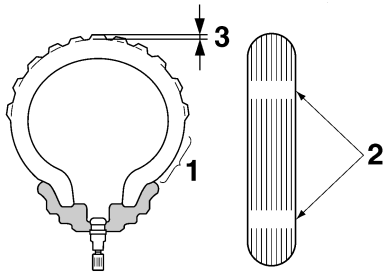

1. Tire sidewall
2. Tire wear indicator
3. Tire tread depth

The tires must be checked before each ride. If the tire shows crosswise lines (minimum tread depth), if the tire has a nail or glass fragments in it, or if the sidewall is cracked, have a Yamaha dealer replace the tire immediately.

Minimum tire tread depth (front and rear):
1.0 mm (0.04 in)

EWA10472



WARNING

- **Have a Yamaha dealer replace excessively worn tires. Besides being illegal, operating the vehi-**

cle with excessively worn tires decreases riding stability and can lead to loss of control.

- **The replacement of all wheel and brake-related parts, including the tires, should be left to a Yamaha dealer, who has the necessary professional knowledge and experience to do so.**
- **Ride at moderate speeds after changing a tire since the tire surface must first be “broken in” for it to develop its optimal characteristics.**

Tire information

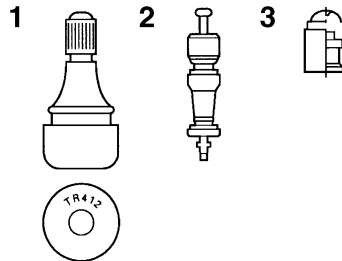

1. Tire air valve
2. Tire air valve core
3. Tire air valve cap with seal

This model is equipped with tubeless tires and tire air valves.

Tires age, even if they have not been used or have only been used occasionally. Cracking of the tread and sidewall rubber, sometimes accompanied by carcass deformation, is an evidence of ageing. Old and aged tires shall be checked by tire specialists to ascertain their suitability for further use.

EWA10482



WARNING

- **The front and rear tires should be of the same make and design, otherwise the handling characteristics of the motorcycle may be different, which could lead to an accident.**
- **Always make sure that the valve caps are securely installed to prevent air pressure leakage.**
- **Use only the tire valves and valve cores listed below to avoid tire deflation during a high-speed ride.**

After extensive tests, only the tires listed below have been approved for this model by Yamaha.

Periodic maintenance and adjustment

EAU21963

Front tire:

Size:

120/70ZR17M/C (58W)

Manufacturer/model:

BRIDGESTONE/BATTLAX
HYPERSPORT S22F

Rear tire:

Size:

180/55ZR17M/C (73W)

Manufacturer/model:

BRIDGESTONE/BATTLAX
HYPERSPORT S22R

FRONT and REAR:

Tire air valve:

TR412

Valve core:

#9100 (original)

“broken in”. Therefore, it is advisable before doing any high-speed riding to ride conservatively for approximately 100 km (60 mi) after installing a new tire.

- **The tires must be warmed up before a high-speed run.**
- **Always adjust the tire air pressure according to the operating conditions.**

Cast wheels

To maximize the performance, durability, and safe operation of your vehicle, note the following points regarding the specified wheels.

- The wheel rims should be checked for cracks, bends, warp-age or other damage before each ride. If any damage is found, have a Yamaha dealer replace the wheel. Do not attempt even the smallest repair to the wheel. A deformed or cracked wheel must be replaced.
- The wheel should be balanced whenever either the tire or wheel has been changed or replaced. An unbalanced wheel can result in poor performance, adverse handling characteristics, and a shortened tire life.

8

EWA10601

WARNING

This motorcycle is fitted with super-high-speed tires. Note the following points in order to make the most efficient use of these tires.

- Use only the specified replacement tires. Other tires may run the danger of bursting at super high speeds.
- Brand-new tires can have a relatively poor grip on certain road surfaces until they have been

Adjusting the clutch lever free play

EAU22083

Measure the clutch lever free play as shown.

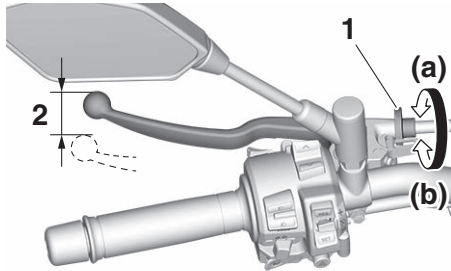

1. Clutch lever free play adjusting bolt
2. Clutch lever free play

Clutch lever free play:
5.0–10.0 mm (0.20–0.39 in)

Periodically check the clutch lever free play and, if necessary, adjust it as follows.

To increase the clutch lever free play, turn the clutch lever free play adjusting bolt in direction (a). To decrease the clutch lever free play, turn the adjusting bolt in direction (b).

TIP _____
If the specified free play cannot be obtained as described above or if the clutch does not operate correctly, have a Yamaha dealer check the internal clutch mechanism.

Checking the brake lever free play

EAU37914

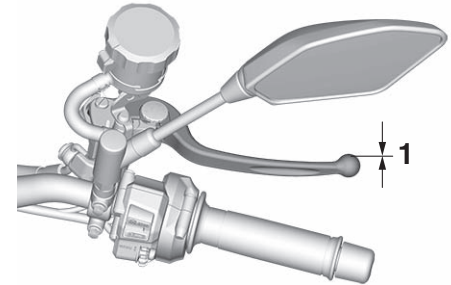

1. No brake lever free play

There should be no free play at the brake lever end. If there is free play, have a Yamaha dealer inspect the brake system.

⚠ WARNING _____

EWA14212

A soft or spongy feeling in the brake lever can indicate the presence of air in the hydraulic system. If there is air in the hydraulic system, have a Yamaha dealer bleed the system before operating the vehicle. Air in the hydraulic system will diminish the

Periodic maintenance and adjustment

braking performance, which may result in loss of control and an accident.

Brake light switches

EAU36505

The brake light should come on just before braking takes effect. The brake light is activated by switches connected to the brake lever and brake pedal. Since the brake light switches are components of the anti-lock brake system, they should only be serviced by a Yamaha dealer.

Checking the front and rear brake pads

EAU22393

The front and rear brake pads must be checked for wear at the intervals specified in the periodic maintenance and lubrication chart.

Front brake pads

EAU36891

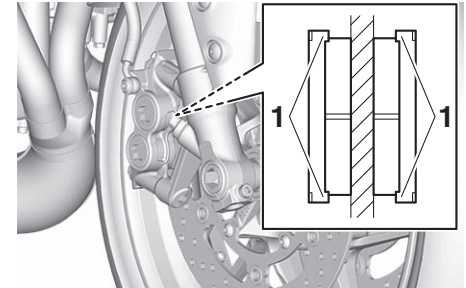

1. Brake pad wear indicator

Each front brake pad is provided with wear indicators, which allows you to check the brake pad wear without having to disassemble the brake. To check the brake pad wear, check the position of the wear indicators while applying the brake. If a brake pad has worn to the point that a wear indicator almost

Periodic maintenance and adjustment

touches the brake disc, have a Yamaha dealer replace the brake pads as a set.

Rear brake pads

EAU46292

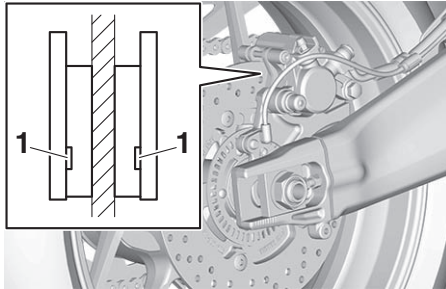

1. Brake pad wear indicator groove

Each rear brake pad is provided with wear indicator grooves, which allow you to check the brake pad wear without having to disassemble the brake. To check the brake pad wear, check the wear indicator grooves. If a brake pad has worn to the point that a wear indicator groove almost appears, have a Yamaha dealer replace the brake pads as a set.

Checking the brake fluid level

EAU66670

Before riding, check that the brake fluid is above the minimum level mark. Check the brake fluid level with the top of the reservoir level. Replenish the brake fluid if necessary.

Front brake

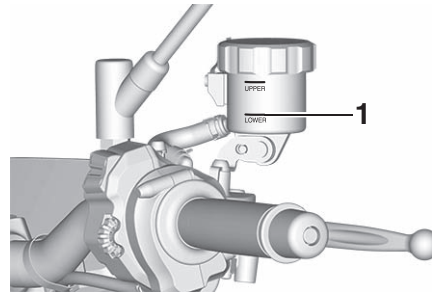

1. Minimum level mark

Rear brake

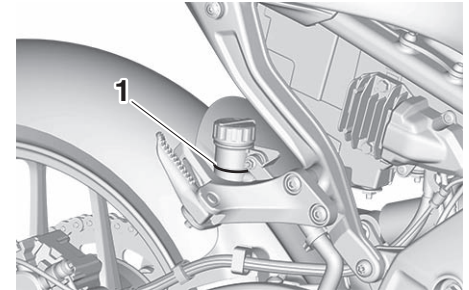

1. Minimum level mark

Specified brake fluid:
YAMAHA GENUINE BRAKE FLUID
(DOT 4)

EWA16011

⚠ WARNING

Improper maintenance can result in loss of braking ability. Observe these precautions:

- **Insufficient brake fluid may allow air to enter the brake system, reducing braking performance.**
- **Clean the filler cap before removing. Use only DOT 4 brake fluid from a sealed container.**

Periodic maintenance and adjustment

- **Use only the specified brake fluid; otherwise, the rubber seals may deteriorate, causing leakage.**
- **Refill with the same type of brake fluid. Adding a brake fluid other than DOT 4 may result in a harmful chemical reaction.**
- **Be careful that water or dust does not enter the brake fluid reservoir when refilling. Water will significantly lower the boiling point of the fluid and may result in vapor lock, and dirt may clog the ABS hydraulic unit valves.**

fluid level goes down suddenly, have a Yamaha dealer check the cause before further riding.

Changing the brake fluid

EAU22734

Have a Yamaha dealer change the brake fluid every 2 years. In addition, have the seals of the master cylinders and brake calipers, as well as the brake hoses replaced at the intervals listed below or sooner if they are damaged or leaking.

- Brake seals: every 2 years
- Brake hoses: every 4 years

8

ECA17641

NOTICE

Brake fluid may damage painted surfaces or plastic parts. Always clean up spilled fluid immediately.

As the brake pads wear, it is normal for the brake fluid level to gradually go down. A low brake fluid level may indicate worn brake pads and/or brake system leakage; therefore, be sure to check the brake pads for wear and the brake system for leakage. If the brake

Periodic maintenance and adjustment

Drive chain slack

EAU22762

The drive chain slack should be checked before each ride and adjusted if necessary.

To check the drive chain slack

EAU91552

1. Place the motorcycle on the side-stand.

TIP _____

When checking and adjusting the drive chain slack, there should be no weight on the motorcycle.

2. Shift the transmission into the neutral position.
3. Find the center point of the chain (position B) by measuring (approx. 32 mm (1.26 in)) forward from the edge of the drive chain guard as shown.

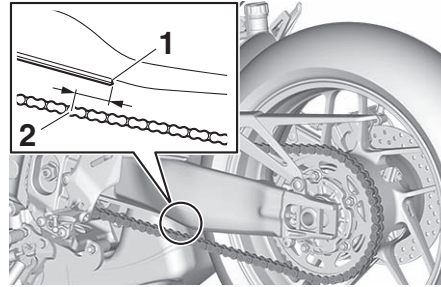

1. Edge of the drive chain guard
2. Position B

4. Push down on the center of the drive chain and measure the distance A from the drive chain guard to the middle of the chain link being pressed down at position B.

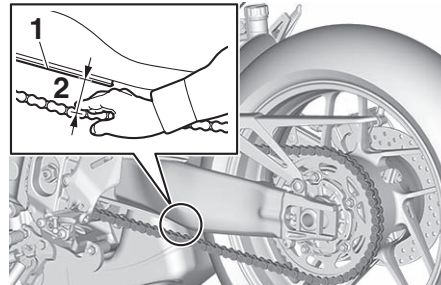

1. Drive chain guard
2. Distance A

Distance A:

36.0–41.0 mm (1.42–1.61 in)

5. If distance A is incorrect, adjust it as follows. **NOTICE: Improper drive chain slack will overload the engine as well as other vital parts of the motorcycle and can lead to chain slippage or breakage. If distance A is more than 46.0 mm (1.81 in), the chain can damage the frame, swingarm, and other parts. To prevent this from occurring, keep the drive chain slack within the specified limits.** [ECA23070]

To adjust the drive chain slack

EAU74260

Consult a Yamaha dealer before adjusting the drive chain slack.

1. Loosen the axle nut and the lock-nut on each side of the swingarm.

Periodic maintenance and adjustment

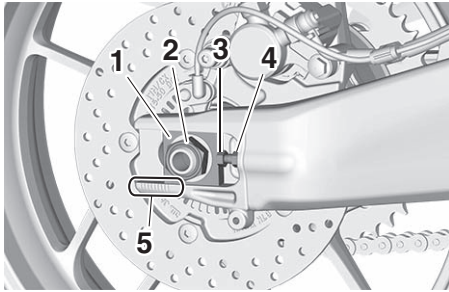

1. Drive chain puller
2. Axle nut
3. Drive chain slack adjusting bolt
4. Locknut
5. Alignment marks

2. To tighten the drive chain, turn the drive chain slack adjusting bolt on each side of the swingarm in direction (a). To loosen the drive chain, turn the adjusting bolt on each side of the swingarm in direction (b), and then push the rear wheel forward.

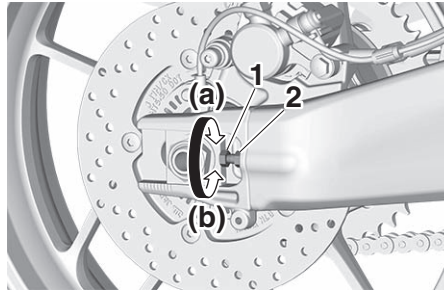

1. Drive chain slack adjusting bolt
2. Locknut

TIP

Using the alignment marks on each side of the swingarm, make sure that both drive chain pullers are in the same position for proper wheel alignment.

3. Tighten the axle nut, then the locknuts to their specified torques.

Tightening torques:

Axle nut:

105 N·m (10.5 kgf·m, 77 lb·ft)

Locknut:

16 N·m (1.6 kgf·m, 12 lb·ft)

4. Make sure that the drive chain pullers are in the same position, the drive chain slack is correct, and the drive chain moves smoothly.

Cleaning and lubricating the drive chain

EAU23027

The drive chain must be cleaned and lubricated at the intervals specified in the periodic maintenance and lubrication chart, otherwise it will quickly wear out, especially when riding in dusty or wet areas. Service the drive chain as follows.

ECA10584

NOTICE

The drive chain must be lubricated after washing the motorcycle, riding in the rain or riding in wet areas.

1. Clean the drive chain with a drive chain cleaner and a small soft brush. **NOTICE: To prevent damaging the O-rings, do not clean the drive chain with steam cleaners, high-pressure washers or inappropriate solvents.**

[ECA11122]

2. Wipe the drive chain dry.
3. Thoroughly lubricate the drive chain with a special O-ring chain lubricant. **NOTICE: Do not use engine oil or any other lubri-**

cants for the drive chain, as they may contain substances that could damage the O-rings.

[ECA11112]

Checking and lubricating the cables

EAU23098

The operation of all control cables and the condition of the cables should be checked before each ride, and the cables and cable ends should be lubricated if necessary. If a cable is damaged or does not move smoothly, have a Yamaha dealer check or replace it. **WARNING! Damage to the outer housing of cables may result in internal rusting and cause interference with cable movement. Replace damaged cables as soon as possible to prevent unsafe conditions.** [EWA10712]

Recommended lubricant:

Yamaha cable lubricant or other suitable cable lubricant

Periodic maintenance and adjustment

Checking and lubricating the throttle grip

EAU82490

The operation of the throttle grip should be checked before each ride. In addition, the throttle grip housing should be lubricated by a Yamaha dealer at the intervals specified in the periodic maintenance chart.

Checking and lubricating the brake and shift pedals

EAU44276

The operation of the brake and shift pedals should be checked before each ride, and the pedal pivots should be lubricated if necessary.

Recommended lubricant:
Lithium-soap-based grease

Brake pedal

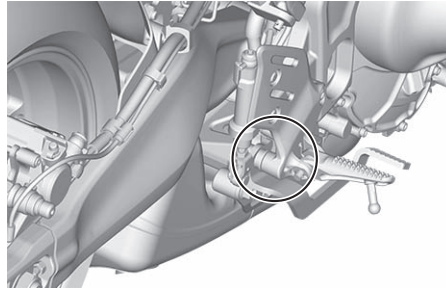

Shift pedal

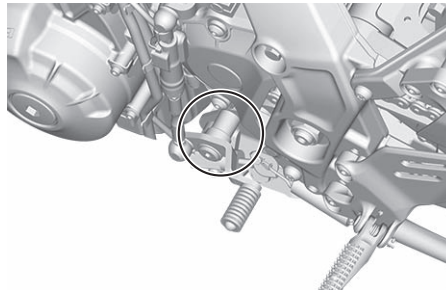

Periodic maintenance and adjustment

Checking and lubricating the brake and clutch levers

EAU23144

The operation of the brake and clutch levers should be checked before each ride, and the lever pivots should be lubricated if necessary.

Brake lever

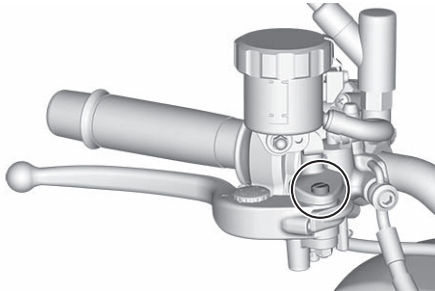

Clutch lever

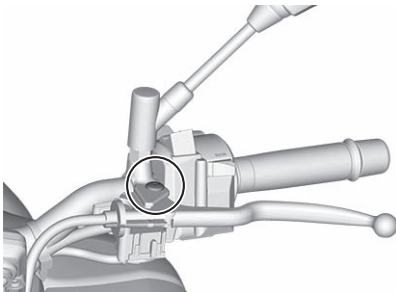

Recommended lubricants:

- Brake lever:
Silicone grease
- Clutch lever:
Lithium-soap-based grease

Checking and lubricating the sidestand

EAU89101

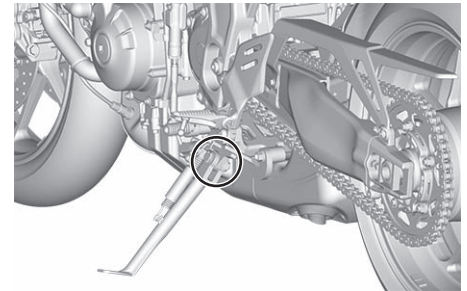

The operation of the sidestand should be checked before each ride, and the sidestand pivot and metal-to-metal contact surfaces should be lubricated if necessary.

8

WARNING

If the sidestand does not move up and down smoothly, have a Yamaha dealer check or repair it. Otherwise, the sidestand could contact the ground and distract the operator, resulting in a possible loss of control.

EWA10732

Recommended lubricant:

- Molybdenum disulfide grease

Periodic maintenance and adjustment

Lubricating the swingarm pivots

EAUM1653

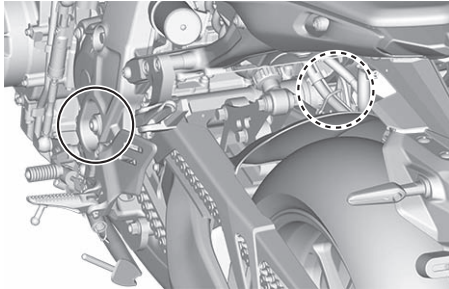

The swingarm pivots must be lubricated by a Yamaha dealer at the intervals specified in the periodic maintenance and lubrication chart.

Recommended lubricant:
Lithium-soap-based grease

Checking the front fork

EAU23273

The condition and operation of the front fork must be checked as follows at the intervals specified in the periodic maintenance and lubrication chart.

To check the condition

Check the inner tubes for scratches, damage and excessive oil leakage.

To check the operation

1. Place the vehicle on a level surface and hold it in an upright position. **WARNING! To avoid injury, securely support the vehicle so there is no danger of it falling over.** [EWA10752]
2. While applying the front brake, push down hard on the handlebars several times to check if the front fork compresses and rebounds smoothly.

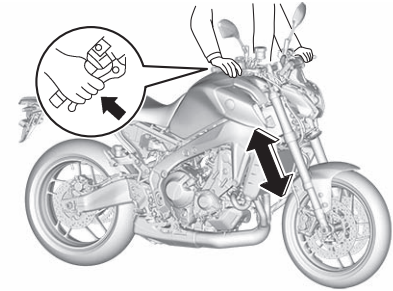

ECA10591

NOTICE

If any damage is found or the front fork does not operate smoothly, have a Yamaha dealer check or repair it.

Checking the steering

EAU23285

Worn or loose steering bearings may cause danger. Therefore, the operation of the steering must be checked as follows at the intervals specified in the periodic maintenance and lubrication chart.

1. Raise the front wheel off the ground. (See page 8-32.) **WARNING! To avoid injury, securely support the vehicle so there is no danger of it falling over.** [EWA10752]
2. Hold the lower ends of the front fork legs and try to move them forward and backward. If any free play can be felt, have a Yamaha dealer check or repair the steering.

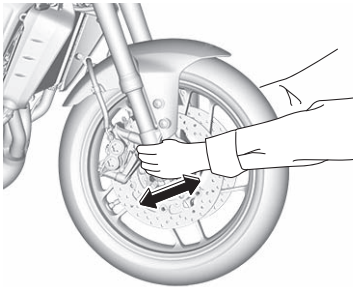

Checking the wheel bearings

EAU23292

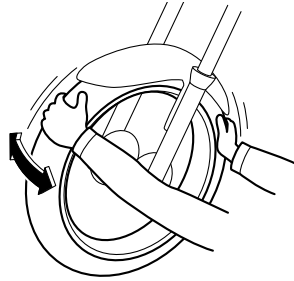

The front and rear wheel bearings must be checked at the intervals specified in the periodic maintenance and lubrication chart. If there is play in the wheel hub or if the wheel does not turn smoothly, have a Yamaha dealer check the wheel bearings.

Battery

EAU93820

ECA22960

NOTICE

Use only the specified genuine YAMAHA battery. Using a different battery may cause the IMU to fail and the engine to stall.

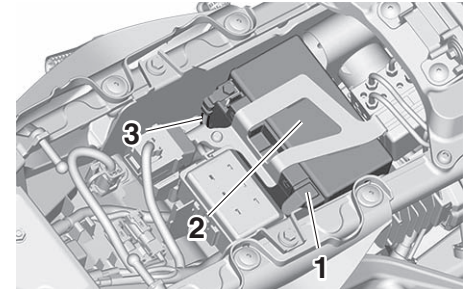

1. Positive battery lead (red)
2. Battery
3. Negative battery lead (black)

The battery is located under the seat. (See page 5-24.)

This model is equipped with a VRLA (Valve Regulated Lead Acid) battery. There is no need to check the electrolyte or to add distilled water. However,

Periodic maintenance and adjustment

the battery lead connections need to be checked and, if necessary, tightened.

EWA10761

WARNING

- **Electrolyte is poisonous and dangerous since it contains sulfuric acid, which causes severe burns. Avoid any contact with skin, eyes or clothing and always shield your eyes when working near batteries. In case of contact, administer the following FIRST AID.**
 - **EXTERNAL:** Flush with plenty of water.
 - **INTERNAL:** Drink large quantities of water or milk and immediately call a physician.
 - **EYES:** Flush with water for 15 minutes and seek prompt medical attention.
- **Batteries produce explosive hydrogen gas. Therefore, keep sparks, flames, cigarettes, etc., away from the battery and provide sufficient ventilation when charging it in an enclosed space.**

- **KEEP THIS AND ALL BATTERIES OUT OF THE REACH OF CHILDREN.**
-

To charge the battery

Have a Yamaha dealer charge the battery as soon as possible if it seems to have discharged. Keep in mind that the battery tends to discharge more quickly if the vehicle is equipped with optional electrical accessories.

ECA16522

NOTICE

To charge a VRLA (Valve Regulated Lead Acid) battery, a special (constant-voltage) battery charger is required. Using a conventional battery charger will damage the battery.

To store the battery

1. If the vehicle will not be used for more than one month, remove the battery, fully charge it, and then place it in a cool, dry place.
NOTICE: When removing the battery, be sure to turn the main

switch off, then disconnect the negative lead before disconnecting the positive lead. [ECA16304]

2. If the battery will be stored for more than two months, check it at least once a month and fully charge it if necessary.
3. Fully charge the battery before installation. **NOTICE: When installing the battery, be sure to turn the main switch off, then connect the positive lead before connecting the negative lead.** [ECA16842]
4. After installation, make sure that the battery leads are properly connected to the battery terminals.

ECA16531

NOTICE

Always keep the battery charged. Storing a discharged battery can cause permanent battery damage.

Periodic maintenance and adjustment

Replacing the fuses

EAU91572

The fuse box is located under the seat.
(See page 5-24.)

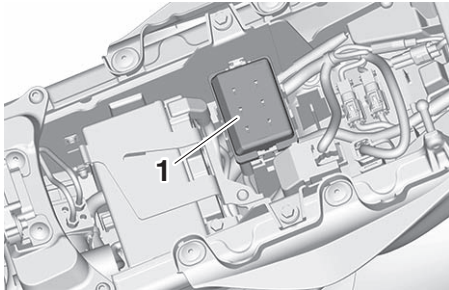

1. Fuse box

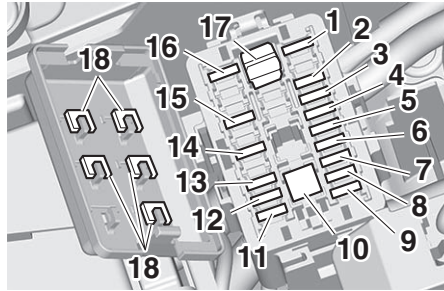

1. Brake light fuse
2. Ignition fuse 2
3. Signaling system fuse
4. Ignition fuse
5. Headlight fuse
6. ABS ECU fuse
7. Fuel injection system fuse
8. Electronic throttle valve fuse
9. Backup fuse 2
10. Main fuse
11. ABS motor fuse
12. ABS solenoid fuse
13. Radiator fan motor fuse
14. Terminal fuse 1
15. Backup fuse
16. Cruise control fuse
17. Fuse puller
18. Spare fuse

If a fuse is blown, replace it as follows.

TIP

- There is a spare fuse on the back side of the fuse box cover.
- Use a fuse puller to remove the fuse.

1. Turn the main switch off and turn off the electrical circuit in question.
2. Remove the fuse box cover by pressing inwards at the two points indicated on the cover and pulling upwards.

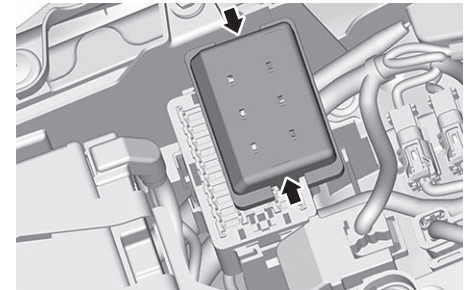

3. Remove the blown fuse using the fuse puller.

Periodic maintenance and adjustment

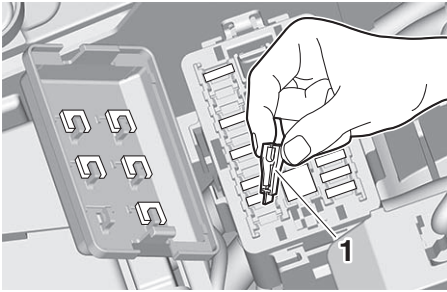

1. Fuse puller

4. Install a new fuse of the specified amperage. **WARNING! Do not use a fuse of a higher amperage rating than recommended to avoid causing extensive damage to the electrical system and possibly a fire.** [EWA15132]

Specified fuses:

- Main fuse:
50.0 A
- Terminal fuse 1:
2.0 A
- Headlight fuse:
7.5 A
- Brake light fuse:
2.0 A
- Signaling system fuse:
7.5 A
- Ignition fuse:
10.0 A
- Ignition fuse 2:
7.5 A
- Radiator fan motor fuse:
15.0 A
- ABS motor fuse:
30.0 A
- ABS ECU fuse:
7.5 A
- Fuel injection system fuse:
7.5 A
- ABS solenoid fuse:
15.0 A
- Cruise control fuse:
2.0 A
- Backup fuse:
7.5 A
- Backup fuse 2:
15.0 A
- Electronic throttle valve fuse:
7.5 A

5. Insert the fuse puller, and then install the fuse box cover.
6. Turn the main switch on and turn on the electrical circuit in question to check if the device operates.
7. If the fuse immediately blows again, have a Yamaha dealer check the electrical system.

ECA27210

NOTICE

Do not drive while the fuse box cover is removed.

Periodic maintenance and adjustment

Vehicle lights

EAU80380

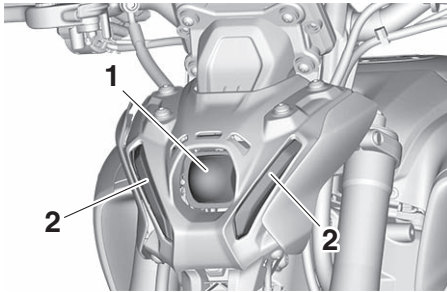

1. Headlight
2. Auxiliary light

Except for the license plate light bulb, this model's lights are all LED.

If an LED light does not come on, check the fuses and then have a Yamaha dealer check the vehicle. If the license plate light does not come on, check and replace the bulb. (See page 8-32.)

ECA16581

NOTICE

Do not affix any type of tinted film or stickers to the headlight lens.

License plate light

EAU24331

If the license plate light does not come on, have a Yamaha dealer check the electrical circuit or replace the bulb.

Supporting the motorcycle

EAU67131

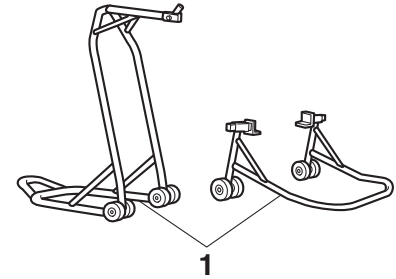

1. Maintenance stand (example)

Since this model is not equipped with a centerstand, use maintenance stands when removing the front or rear wheel or when performing other maintenance that requires the motorcycle to stand up right.

Check that the motorcycle is in a stable and level position before starting any maintenance.

Periodic maintenance and adjustment

EAU25872

Troubleshooting

Although Yamaha motorcycles receive a thorough inspection before shipment from the factory, trouble may occur during operation. Any problem in the fuel, compression, or ignition systems, for example, can cause poor starting and loss of power.

The following troubleshooting charts represent quick and easy procedures for checking these vital systems yourself. However, should your motorcycle require any repair, take it to a Yamaha dealer, whose skilled technicians have the necessary tools, experience, and know-how to service the motorcycle properly.

Use only genuine Yamaha replacement parts. Imitation parts may look like Yamaha parts, but they are often inferior, have a shorter service life and can lead to expensive repair bills.

EWA15142

WARNING

When checking the fuel system, do not smoke, and make sure there are no open flames or sparks in the area, including pilot lights from water

heaters or furnaces. Gasoline or gasoline vapors can ignite or explode, causing severe injury or property damage.

Troubleshooting chart

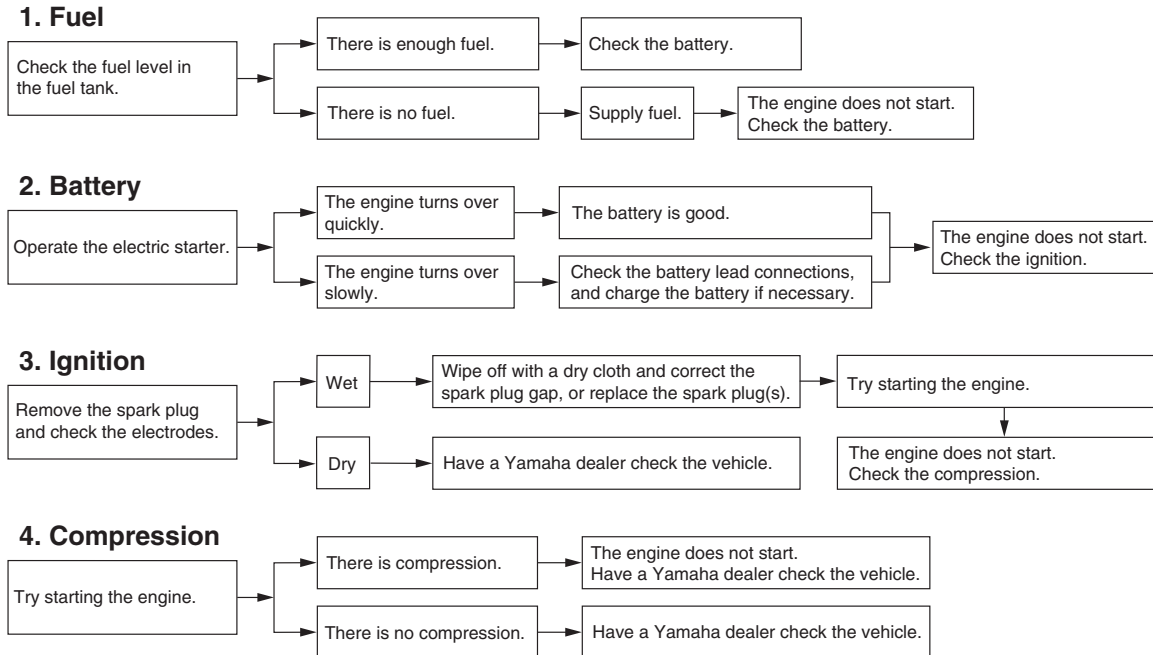

Periodic maintenance and adjustment

EAU86420

Engine overheating

EWAT1041

⚠ WARNING

- Do not remove the radiator cap when the engine and radiator are hot. Scalding hot fluid and steam may be blown out under pressure, which could cause serious injury. Be sure to wait until the engine has cooled.
- Place a thick rag, like a towel, over the radiator cap, and then slowly rotate the cap counterclockwise to the detent to allow any residual pressure to escape. When the hissing sound has stopped, press down on the cap while turning it counterclockwise, and then remove the cap.

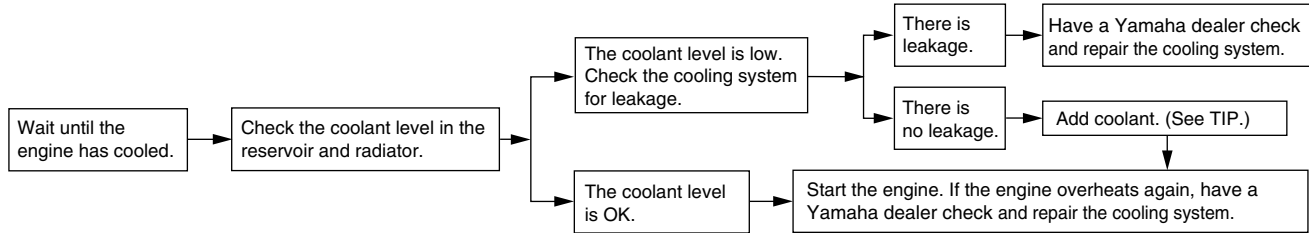

TIP

If coolant is not available, tap water can be temporarily used instead, provided that it is changed to the recommended coolant as soon as possible.

Matte color caution

EAU37834

EAU84991

NOTICE

Some models are equipped with matte colored finished parts. Be sure to consult a Yamaha dealer for advice on what products to use before cleaning the vehicle. Using a brush, harsh chemical products or cleaning compounds when cleaning these parts will scratch or damage their surface. Wax also should not be applied to any matte colored finished parts.

ECA15193

Care

Frequent, thorough cleaning of the vehicle will not only enhance its appearance but also will improve its general performance and extend the useful life of many components. Washing, cleaning, and polishing will also give you a chance to inspect the condition of the vehicle more frequently. Be sure to wash the vehicle after riding in the rain or near the sea, because salt is corrosive to metals.

TIP

- Genuine Yamaha care and maintenance products are sold under the YAMALUBE brand in many markets worldwide.
- See your Yamaha dealer for additional cleaning tips.

ECA26280

NOTICE

Improper cleaning can cause cosmetic and mechanical damage. Do not use:

- high-pressure washers or steam-jet cleaners. Excessive water pressure may cause wa-

ter seepage and deterioration of wheel bearings, brakes, transmission seals and electrical devices. Avoid high-pressure detergent applications such as those available in coin-operated car washers.

- harsh chemicals, including strong acidic wheel cleaners, especially on spoke or magnesium wheels.
- harsh chemicals, abrasive cleaning compounds, or wax on matte-finished parts. Brushes can scratch and damage the matte-finish, use soft sponge or towel only.
- towels, sponges, or brushes contaminated with abrasive cleaning products or strong chemicals such as, solvents, gasoline, rust removers, brake fluid, or antifreeze, etc.

Before washing

1. Park the vehicle out of direct sunlight and allow it to cool. This will help avoid water spots.

Motorcycle care and storage

2. Make sure all caps, covers, electrical couplers and connectors are tightly installed.
3. Cover the muffler end with a plastic bag and a strong rubber band.
4. Pre-soak stubborn stains like insects or bird droppings with a wet towel for a few minutes.
5. Remove road grime and oil stains with a quality degreasing agent and a plastic-bristle brush or sponge. **NOTICE: Do not use degreasing agent on areas requiring lubrication such as seals, gaskets, and wheel axles. Follow product instructions.**

[ECA26290]

9

Washing

1. Rinse off any degreaser and spray down the vehicle with a garden hose. Use only enough pressure to do the job. Avoid spraying water directly into the muffler, instrument panel, air inlet, or other inner areas such as underseat storage compartments.
2. Wash the vehicle with a quality automotive-type detergent mixed with cool water and a soft, clean towel or sponge. Use an old toothbrush or plastic-bristle brush for hard-to-reach places. **NOTICE: Use cold water if the vehicle has been exposed to salt. Warm water will increase salt's corrosive properties.** [ECA26301]
3. For windshield-equipped vehicles: Clean the windshield with a soft towel or sponge dampened with water and a pH neutral detergent. If necessary, use a high-quality windshield cleaner or polish for motorcycles. **NOTICE: Never use any strong chemicals to clean the windshield. Additionally, some cleaning compounds for plastic may scratch the windshield, so be sure to test all cleaning products before general application.** [ECA26310]
4. Rinse off thoroughly with clean water. Be sure to remove all detergent residues, as they can be harmful to plastic parts.

After washing

1. Dry the vehicle with a chamois or absorbent towel, preferably microfiber terrycloth.
2. For drive chain-equipped models: Dry and then lubricate the drive chain to prevent rust.
3. Use a chrome polish to shine chrome, aluminum, and stainless steel parts. Often the thermally induced discoloring of stainless steel exhaust systems can be removed through polishing.
4. Apply a corrosion protection spray on all metal parts including chrome or nickel-plated surfaces. **WARNING! Do not apply silicone or oil spray to seats, hand grips, rubber foot pegs or tire treads. Otherwise these parts will become slippery, which could cause loss of control. Thoroughly clean the surfaces of these parts before operating the vehicle.** [EWA20651]
5. Treat rubber, vinyl, and unpainted plastic parts with a suitable care product.

6. Touch up minor paint damage caused by stones, etc.
7. Wax all painted surfaces using a non-abrasive wax or use a detail spray for motorcycles.
8. When finished cleaning, start the engine and let it idle for several minutes to help dry any remaining moisture.
9. If the headlight lens has fogged up, start the engine and turn on the headlight to help remove the moisture.
10. Let the vehicle dry completely before storing or covering it.

ECA26320

NOTICE

- Do not apply wax to rubber or unpainted plastic parts.
- Do not use abrasive polishing compounds as they will wear away the paint.
- Apply sprays and wax sparingly. Wipe off excess afterwards.

EWA20660



WARNING

Contaminants left on the brakes or tires can cause loss of control.

- Make sure there is no lubricant or wax on the brakes or tires.
- If necessary, wash the tires with warm water and a mild detergent.
- If necessary, clean the brake discs and pads with brake cleaner or acetone.
- Before riding at higher speeds, test the vehicle's braking performance and cornering behavior.

Storage

Always store the vehicle in a cool, dry place. If necessary, protect it against dust with a porous cover. Be sure the engine and the exhaust system are cool before covering the vehicle. If the vehicle often sits for weeks at a time between uses, the use of a quality fuel stabilizer is recommended after each fill-up.

ECA21170

NOTICE

- Storing the vehicle in a poorly ventilated room or covering it with a tarp, while it is still wet, will allow water and humidity to seep in and cause rust.
- To prevent corrosion, avoid damp cellars, stables (because of the presence of ammonia) and areas where strong chemicals are stored.

Long term storage

Before storing the vehicle long term (60 days or more):

Motorcycle care and storage

1. Make all necessary repairs and perform any outstanding maintenance.
2. Follow all instructions in the Care section of this chapter.
3. Fill up the fuel tank, adding fuel stabilizer according to product instructions. Run the engine for 5 minutes to distribute treated fuel through the fuel system.
4. For vehicles equipped with a fuel cock: Turn the fuel cock lever to the off position.
5. For vehicles with a carburetor: To prevent fuel deposits from building up, drain the fuel in the carburetor float chamber into a clean container. Retighten the drain bolt and pour the fuel back into the fuel tank.
6. Use a quality engine fogging oil according to product instructions to protect internal engine components from corrosion. If engine fogging oil is not available, perform the following steps for each cylinder:
 - a. Remove the spark plug cap and spark plug.
 - b. Pour a teaspoonful of engine oil into the spark plug bore.
 - c. Install the spark plug cap onto the spark plug, and then place the spark plug on the cylinder head so that the electrodes are grounded. (This will limit sparking during the next step.)
 - d. Turn the engine over several times with the starter. (This will coat the cylinder wall with oil.)
WARNING! To prevent damage or injury from sparking, make sure to ground the spark plug electrodes while turning the engine over.
[EWA10952]
 - e. Remove the spark plug cap from the spark plug, and then install the spark plug and the spark plug cap.
7. Lubricate all control cables, pivots, levers and pedals, as well as the sidestand and centerstand (if equipped).
8. Check and correct the tire air pressure, and then lift the vehicle so that all wheels are off the ground. Otherwise, turn the wheels a little once a month in order to prevent the tires from becoming degraded in one spot.
9. Cover the muffler outlet with a plastic bag to prevent moisture from entering it.
10. Remove the battery and fully charge it, or attach a maintenance charger to keep the battery optimally charged. **NOTICE: Confirm that the battery and its charger are compatible. Do not charge a VRLA battery with a conventional charger.**[ECA26330]

TIP

- If the battery will be removed, charge it once a month and store it in a temperate location between 0-30 °C (32-90 °F).
 - See page 8-28 for more information on charging and storing the battery.
-

Dimensions:

- Overall length:
2090 mm (82.3 in)
- Overall width:
795 mm (31.3 in)
- Overall height:
1190 mm (46.9 in)
- Seat height:
825 mm (32.5 in)
- Wheelbase:
1430 mm (56.3 in)
- Ground clearance:
140 mm (5.51 in)
- Minimum turning radius:
3.4 m (11.16 ft)

Weight:

- Curb weight:
190 kg (419 lb)

Engine:

- Combustion cycle:
4-stroke
- Cooling system:
Liquid cooled
- Valve train:
DOHC
- Cylinder arrangement:
Inline
- Number of cylinders:
3-cylinder
- Displacement:
890 cm³
- Bore × stroke:
78.0 × 62.1 mm (3.07 × 2.44 in)

- Starting system:
Electric starter

Engine oil:

- Recommended brand:



- SAE viscosity grades:
10W-40
- Recommended engine oil grade:
API service SG type or higher, JASO standard MA
- Engine oil quantity:
Oil change:
2.80 L (2.96 US qt, 2.46 Imp.qt)
With oil filter removal:
3.20 L (3.38 US qt, 2.82 Imp.qt)

Coolant quantity:

- Coolant reservoir (up to the maximum level mark):
0.28 L (0.30 US qt, 0.25 Imp.qt)
- Radiator (including all routes):
1.72 L (1.82 US qt, 1.51 Imp.qt)

Fuel:

- Recommended fuel:
Unleaded gasoline (E10 acceptable)
- Octane number (RON):
95
- Fuel tank capacity:
14 L (3.7 US gal, 3.1 Imp.gal)
- Fuel reserve amount:
2.8 L (0.74 US gal, 0.62 Imp.gal)

Fuel injection:

- Throttle body:
ID mark:
B7N1

Drivetrain:

- Gear ratio:
1st:
2.571 (36/14)
2nd:
1.947 (37/19)
3rd:
1.619 (34/21)
4th:
1.381 (29/21)
5th:
1.190 (25/21)
6th:
1.037 (28/27)

Front tire:

- Type:
Tubeless
- Size:
120/70ZR17M/C (58W)
- Manufacturer/model:
BRIDGESTONE/BATTLAX HYPERSPORT S22F

Rear tire:

- Type:
Tubeless
- Size:
180/55ZR17M/C (73W)
- Manufacturer/model:
BRIDGESTONE/BATTLAX HYPERSPORT S22R

Specifications

Loading:

Maximum load:

166 kg (366 lb)

(Total weight of rider, passenger, cargo and accessories)

Auxiliary light:

LED

License plate light:

5.0 W

Front brake:

Type:

Hydraulic dual disc brake

Rear brake:

Type:

Hydraulic single disc brake

Front suspension:

Type:

Telescopic fork

Rear suspension:

Type:

Swingarm (link suspension)

Electrical system:

System voltage:

12 V

Battery:

Model:

YTZ10S

Voltage, capacity:

12 V, 8.6 Ah (10 HR)

Bulb wattage:

Headlight:

LED

Brake/tail light:

LED

Front turn signal light:

LED

Rear turn signal light:

LED

Identification numbers

EAU53562

Record the vehicle identification number, engine serial number, and the model label information in the spaces provided below. These identification numbers are needed when registering the vehicle with the authorities in your area and when ordering spare parts from a Yamaha dealer.

VEHICLE IDENTIFICATION NUMBER:

ENGINE SERIAL NUMBER:

MODEL LABEL INFORMATION:

Vehicle identification number

EAU26401

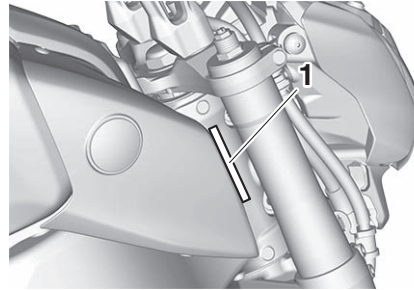

1. Vehicle identification number

The vehicle identification number is stamped into the steering head pipe. Record this number in the space provided.

TIP

The vehicle identification number is used to identify your motorcycle and may be used to register your motorcycle with the licensing authority in your area.

Engine serial number

EAU26442

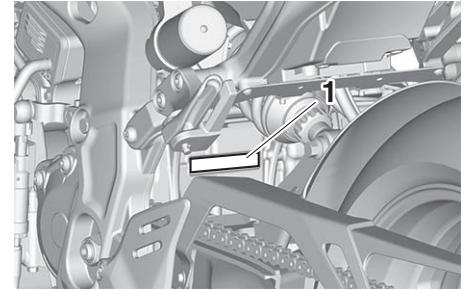

1. Engine serial number

The engine serial number is stamped into the crankcase.

Model label

EAU26481

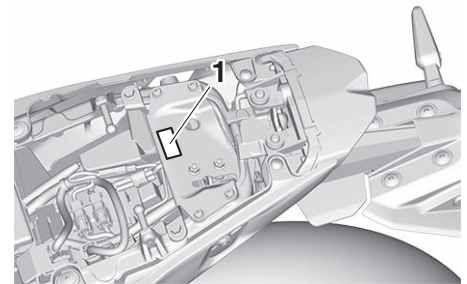

1. Model label

Consumer information

The model label is affixed to the frame under the seat. (See page 5-24.) Record the information on this label in the space provided. This information will be needed when ordering spare parts from a Yamaha dealer.

Diagnostic connector

EAU69910

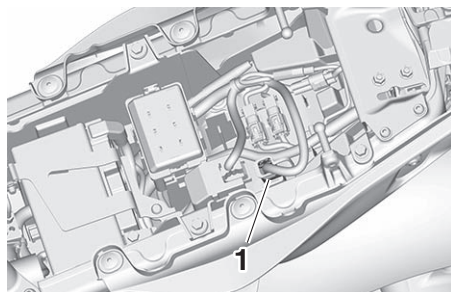

1. Diagnostic connector

The diagnostic connector is located as shown.

Vehicle data recording

EAU85400

This model's ECU stores certain vehicle data to assist in the diagnosis of malfunctions and for research, statistical analysis and development purposes.

Although the sensors and recorded data will vary by model, the main data points are:

- Vehicle status and engine performance data
- Fuel-injection and emission-related data

This data will be uploaded only when a special Yamaha diagnostic tool is attached to the vehicle, such as when maintenance checks or service procedures are performed.

Yamaha will not disclose this data to a third party except in the following cases. In addition, Yamaha may provide vehicle data to a contractor in order to outsource services related to the handling of vehicle data. Even in this case, Yamaha will require the contractor to

properly handle the vehicle data we provided and Yamaha will appropriately manage the data.

- With the consent of the vehicle owner
- Where obligated by law
- For use by Yamaha in litigation
- When the data is not related to an individual vehicle nor owner

Index

- A**
ABS warning light 5-6
Air filter element 8-14
Auxiliary DC connectors 5-30
Auxiliary system warning light 5-8
- B**
Battery 8-28
BC 4-6
Brake and clutch levers, checking and lubricating 8-26
Brake and shift pedals, checking and lubricating 8-25
Brake control system (BC) 5-19
Brake fluid, changing 8-21
Brake fluid level, checking 8-20
Brake lever 5-19
Brake lever free play, checking 8-18
Brake light switches 8-19
Brake pedal 5-19
- C**
Cables, checking and lubricating 8-24
Canister 8-10
Care 9-1
Catalytic converter 5-23
Clutch lever 5-18
Clutch lever free play, adjusting 8-18
Coolant 8-13
Cruise control indicator lights 5-6
Cruise control switches 5-4
Cruise control system 4-1
- D**
Data recording, vehicle 11-2
Diagnostic connector 11-2
Dimmer/Pass switch 5-3
- Display 5-8
Display, menu screen 5-13
D-MODE 4-3
Drive chain, cleaning and lubricating ... 8-24
Drive chain slack 8-22
- E**
Engine break-in 7-1
Engine idling speed, checking 8-14
Engine oil 8-10
Engine overheating 8-35
Engine serial number 11-1
Engine trouble warning light 5-6
- F**
Front and rear brake pads, checking ... 8-19
Front fork, adjusting 5-25
Front fork, checking 8-27
Fuel 5-21
Fuel consumption, tips for reducing 7-5
Fuel level warning light 5-6
Fuel tank cap 5-21
Fuel tank overflow hose 5-23
Fuses, replacing 8-30
- H**
Handlebar position, adjusting 5-25
Handlebar switches 5-3
Hazard switch 5-4
Helmets 2-5
High beam indicator light 5-6
Horn switch 5-4
- I**
Identification numbers 11-1
Ignition circuit cut-off system 5-31
Immobilizer system 5-1
Immobilizer system indicator light 5-7
- Indicator lights and warning lights 5-5
- L**
Labels, location 1-1
License plate light 8-32
Luggage strap holders 5-30
- M**
Main switch/steering lock 5-2
Maintenance and lubrication, periodic 8-5
Maintenance, emission control system 8-3
Matte color, caution 9-1
Model label 11-1
- N**
Neutral indicator light 5-6
- O**
Oil pressure and Coolant temperature warning light 5-7
- P**
Parking 7-5
Part locations 3-1
- Q**
Quick shifter 4-6
- R**
Rider footrest position, adjusting 5-24
- S**
Safety information 2-1
Seat 5-24
Shifting 7-3
Shift pedal 5-18
Shock absorber assembly, adjusting 5-28
Sidestand 5-30
Sidestand, checking and lubricating 8-26
Spark plugs, checking 8-9
Special features 4-1

Specifications	10-1
Stability control indicator light.....	5-7
Starting the engine	7-2
Steering, checking.....	8-28
Stop/Run/Start switch	5-4
Storage	9-3
Supporting the motorcycle.....	8-32
Swingarm pivots, lubricating	8-27

T

TCS-MODE.....	4-4
Throttle grip, checking and lubricating.....	8-25
Tires.....	8-15
Tool kit.....	8-2
Troubleshooting.....	8-33
Troubleshooting chart	8-34
Turn signal indicator lights	5-6
Turn signal switch.....	5-3

V

Valve clearance	8-15
Vehicle identification number	11-1
Vehicle lights	8-32

W

Wheel bearings, checking	8-28
Wheels.....	8-17

Y

Yamalube.....	8-12
---------------	------



PRINTED IN JAPAN
2021.12-0.3×1 CR (E)